

MALOUF



2024 PRICE LIST 1/4

MALOUF™

DISCOVER MALOUF™

pages 4-9

ADJUSTABLE BASES

pages 10-29

MATTRESSES

pages 30-59

FURNITURE

pages 60-71

PROTECTORS

pages 72-89

BEDDING

pages 90-105

PILLOWS

pages 106-151

BED FRAMES

pages 152-157

MATTRESS TOPPERS

pages 158-163

POINT OF PURCHASE

pages 164-181



We believe in a

PEOPLE-FIRST

approach to business

It's our goal to give you the best quality, pricing, and service through innovative products, aggressive shipping policies, marketing support, and an online review and MAP strategy.

We also know that today's customers look for value in more than just what they're spending. They want their dollars to do good—and so do we.

Since 2016, we've proudly supported the Malouf Foundation, and since 2019, we've been Utah's largest Certified B Corporation™.

What started as a company-run foundation has blossomed into a nationally recognized 501(c)3 organization working to end sexual exploitation in the United States. Let's make the world better, together.



MALOUF™

PRICE LIST | VERSION 24.4

SHIPPING GUIDELINES

Case Packs & MOQ

- No minimum order quantities
- No charge for splitting case packs
- For optimal shipping economies, individual units should add up to complete case packs

Shipping

Shipping charges are calculated from the nearest Malouf™ distribution center.

The following shipping discounts are available (continental U.S. only):

- Orders with a qualifying product total above \$1,500 receive free shipping (see below)
- Orders with a qualifying product total over \$750 receive half-price shipping

WHAT'S INCLUDED IN FREE SHIPPING?

Free shipping includes ground shipping to a business address with the carrier of our choice. Extra charges such as inside delivery, liftgate delivery, delivery appointments, etc. will be billed on your next invoice.

ORDER QUANTITIES

For optimal shipping economies, order quantities that are multiples of the case pack number listed on top of each pricing table.

Drop-Shipping Program

Our Endless Aisle Drop-Ship program gives your customers our full range of colors and sizes without you having to crowd your warehouse.

- Place a drop-ship order easily on the Wholesale Resource Center (WRC) or by email, phone, or fax
- Most orders ship within 2 business days, giving your customers a quick turnaround that's not typically associated with special ordering
- Shipping charges vary by order size and destination (including large item delivery and service accessories) and will be billed with the product cost
- Drop-ship fees are waived when customers live within 100 miles of your store; customers living outside the 100-mile radius are charged an additional \$8 per order

PLACING ORDERS

Order Processing

We accept orders in the Wholesale Resource Center on *maloufhome.com*, through AmpTab, or email, phone, or fax.

For order-related questions, we will email you before processing your order—please respond quickly to ensure timely shipping.

Once your order has been processed and shipped, an invoice will be sent to you with tracking information.

To receive invoices by mail, or to receive tracking information separately, let us know when you sign up or email orders@maloufhome.com.

NOTE:

Product packaging is updated throughout the year and may look different in your order.

Inputting Color-Variable SKUs

Given the large quantity of sheet and pillowcase SKUs, we use a shorthand system to select colors.

MA90SK_MS

The underscore (_) indicates a two-letter code inserted into the underscored space.

For example, to choose *White*, WH is entered in the underscored space.

WH
↓
MA90SK_↓MS

The final SKU for ordering would be:

MA90SKWHMS

The price specified on a size applies to all colors available.

CONTACT MALOUF™

WRC	wrc.maloufhome.com	Phone	1.800.517.7179
Email	orders@maloufhome.com sales@maloufhome.com customerservice@maloufhome.com	Fax	1.435.514.0620
		Mail	Malouf™ 1525 West 2960 South Logan, Utah 84321



- ✓ View order status and tracking
- ✓ Build new orders and duplicate past orders
- ✓ See account balance and order history
- ✓ View and pay invoices
- ✓ Review map and pricing
- ✓ Explore product features
- ✓ Download training videos and images
- ✓ Access marketing assets
- ➔ **Create an account at wrc.maloufhome.com**

ORDERING MADE SIMPLE

with the Wholesale Resource Center

Our online resource center was designed to simplify your life, whether you're a buyer, manager, owner, or retail sales associate.

Easy to navigate and explore, the WRC is an incredibly valuable tool for our business. It provides us with real-time information...so our staff has everything they need at their fingertips.

RYAN BATY, THE MATTRESS HUB

ADJUSTABLE BED BASES



Teach customers the health and wellness benefits that come from sleeping elevated, and you'll open an incredible avenue for sales. Our bases range from basic to luxury in a variety of competitive price points.

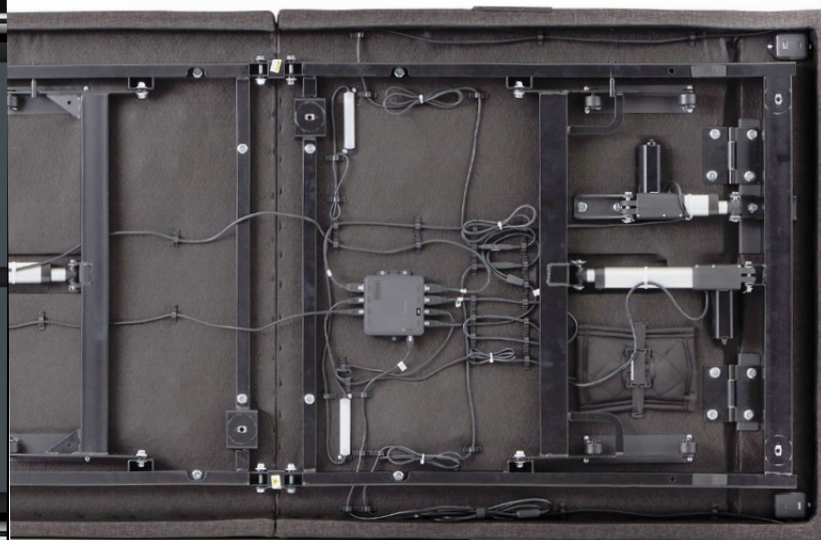

PREMIUM TECHNOLOGY

MEETS SUPERIOR SERVICE

Industry-Leading App

- Siri® Shortcut Voice Commands
- Partner Control
- Snore Detection
- Dark Mode
- Personalized Settings



Easy for Customers, Simple for You

Mix and match bases in a single container for customized offering

Award-winning customer service specializing in our adjustable bases; accepts calls, texts, or emails for troubleshooting

Established technician network across U.S. handles any issues

Proven quality record with less than one percent service rate

Malouf Base App™ is built and maintained in-house for peak performance and responsiveness

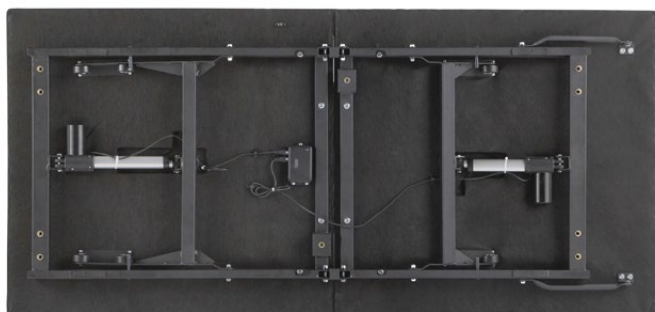

E255 ADJUSTABLE BED BASE

- Independent head incline: 0 - 60°
- Independent foot incline 0 - 45°
- 15-inch height from floor to top of base; includes 12-inch legs; modular legs available in additional sizes
- Wireless remote control
- Three preset positions: Zero Gravity, Anti-Snore, and Flat
- Two programmable positions can be customized and saved
- True zero clearance; remove the legs to place directly on foundations, platform bases, slat beds, or ground
- Upholstered with linen-inspired fabric
- 750-pound weight capacity on all sizes
- All sizes foldable for easy storage; Twin XL and Split California King can be shipped by FedEx and UPS
- Set up in 15 minutes from start to finish
- 10-year limited warranty guarantees high-quality construction

NOTE: Additional entry-level adjustable bases available in the Weekender™ product line

Adjustable Base

SIZE	SKU	PRICE
Twin XL	STMAE255TXAB	300.00
Split California King (half)	STMAE255SCAB	300.00
Full	STMAE255FFAB	350.00
Queen	STMAE255QQAB	350.00
King	STMAE255KKAB	525.00
California King	STMAE255CKAB	525.00

Accessories and POP

SIZE	SKU	PRICE
Headboard Bracket Set	RP - NS01M0DHBXB	20.00
Retainer Bar Cover POP	MA01STRBC	20.00

No MOQ

E455 SMART ADJUSTABLE BED BASE

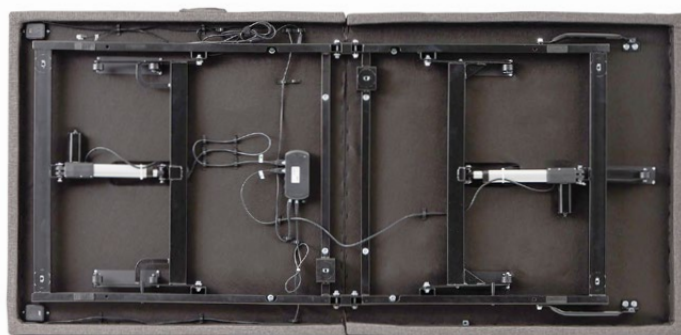

BLUETOOTH®



APP

- Independent head incline: 0 – 60°, foot incline: 0 – 45°
- 15-inch height from floor to top of base; includes 3", 3", 6" legs; modular legs available in additional sizes
- Backlit, wireless remote control, batteries included
- Three preset positions: Zero Gravity, Anti-Snore, and Flat
- Two programmable positions can be customized and saved
- True zero clearance; remove the legs to place directly on foundations, platform bases, slat beds, or ground (now includes slat stabilizer brackets)
- Dual 5V 1.5A charging ports located on both sides of base
- Bluetooth® with the and industry-leading Malouf Base App™; Siri Shortcut voice commands and automatic snore detection available
- Headboard brackets and other leg sizes available upon request
- Upholstered in linen-inspired fabric
- 850-pound weight capacity on all sizes
- All sizes foldable for easy storage; Twin, Twin XL, and Split California King can be shipped by FedEx and UPS
- Set up in 15 minutes from start to finish
- 20-year limited warranty guarantees high-quality construction

Adjustable Base

SIZE	SKU	PRICE
Twin	STMAE455TTAB	375.00
Twin XL	STMAE455TXAB	375.00
Split California King (Half)	STMAE455SCAB	375.00
Full	STMAE455FFAB	425.00
Queen	STMAE455QQAB	425.00
King	STMAE455KKAB	600.00

Accessories and POP

SIZE	SKU	PRICE
Headboard Bracket Set	RP-NS01MODHBBX	20.00
Retainer Bar Cover POP	MA01STRBC	20.00

No MOQ

M455 SMART ADJUSTABLE BED BASE

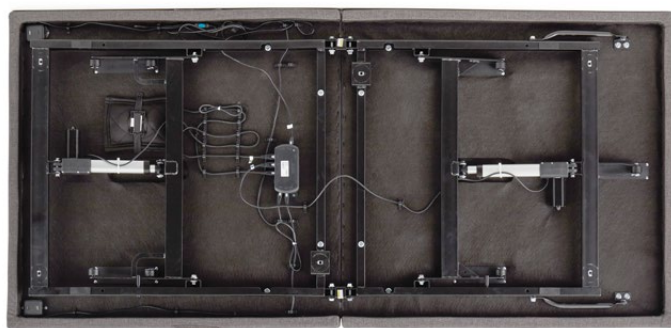

BLUETOOTH®



APP

- Independent head incline: 0 – 60°, foot incline: 0 – 45°
- 15-inch height from floor to top of base; includes 3", 3", 6" legs; modular legs available in additional sizes
- Backlit, wireless remote control, batteries included
- Two preset positions: Zero Gravity and Flat
- One programmable position can be customized and saved
- True zero clearance; remove the legs to place directly on foundations, platform bases, slat beds, or ground (now includes slat stabilizer brackets)
- Dual 5V 1.5A charging ports located on both sides of base
- Zoned neck and back massage with three intensities
- Bluetooth® with the and industry-leading Malouf Base App™; Siri® Shortcut voice commands and automatic snore detection available
- Headboard brackets and other leg sizes available upon request
- Upholstered in linen-inspired fabric
- 850-pound weight capacity on all sizes
- All sizes foldable for easy storage; Twin XL and Split California King can be shipped by FedEx and UPS
- Set up in 15 minutes from start to finish
- 20-year limited warranty guarantees high-quality construction

Adjustable Base

SIZE	SKU	PRICE
Twin XL	STMAM455TXAB	425.00
Split Queen (Half)	STMAM455SQAB	425.00
Split California King (Half)	STMAM455SCAB	425.00
Full	STMAM455FFAB	475.00
Queen	STMAM455QQAB	475.00
King	STMAM455KKAB	650.00

Accessories and POP

SIZE	SKU	PRICE
Headboard Bracket Set	RP-NS01MODHBBX	20.00
Retainer Bar Cover POP	MA01STRBC	20.00

No MOQ

M555 SMART ADJUSTABLE BED BASE

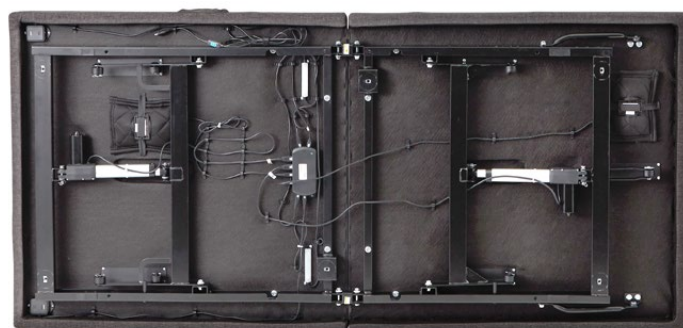

- Independent head incline: 0 – 60°, foot incline: 0 – 45°
- 15-inch height from floor to top of base; includes 3", 3", 6" legs; modular legs available in additional sizes
- LED backlit wireless remote control, batteries included
- Five preset positions: Zero Gravity, Anti-Snore, Lounge, TV, and Flat
- Five programmable positions can be customized and saved
- True zero clearance; remove the legs to place directly on foundations, platform bases, slat beds, or ground (now includes slat stabilizer brackets)
- Dual 5V 1.5A charging ports located on both sides of base
- Bluetooth® with the and industry-leading Malouf Base App™; Siri® Shortcut voice commands and automatic snore detection available
- 12 dual-zone massage options: 4 types, 3 intensities with 3 time settings
- Underbed LED nightlights
- Child-lock safety feature
- Headboard brackets and other leg sizes available upon request
- Upholstered in linen-inspired fabric
- 850-pound weight capacity on all sizes
- All sizes foldable for easy storage; Twin, Twin XL, Split Queen, and Split California King can be shipped by FedEx and UPS
- Set up in 15 minutes from start to finish
- 20-year limited warranty guarantees high-quality construction

Adjustable Base

SIZE	SKU	PRICE
Twin XL	STMAM555TXAB	500.00
Split Queen (Half)	STMAM555SQAB	500.00
Split California King (Half)	STMAM555SCAB	500.00
Full	STMAM555FFAB	550.00
Queen	STMAM555QQAB	550.00
King	STMAM555KKAB	725.00
California King	STMAM555CKAB	725.00

Accessories

SIZE	SKU	PRICE
Headboard Bracket Set	RP-NS01M0DHBBX	20.00
Retainer Bar Cover POP	MA01STRBC	20.00

No MOQ



BLUETOOTH™



APP

S655 SMART ADJUSTABLE BED BASE



- Independent head incline: 0 – 60°, foot incline: 0 – 45°
- 15-inch height from floor to top of base; includes 3", 3", 6" legs; modular legs available in additional sizes
- Head tilt helps improve breathing and eliminate snoring
- Motion-activated LED backlit wireless remote control, batteries included
- Seven preset positions including Zero Gravity, Anti-Snore, and Lounge
- Six programmable positions can be customized and saved
- True zero clearance; remove the legs to place directly on foundations, platform bases, slat beds, or ground (now includes slat stabilizer brackets)
- Dual 5V 1.5A charging ports located on both sides of base
- Nine dual-zone massage options: 3 programs, 3 intensities, 3 timers
- Bluetooth® with the and industry-leading Malouf Base App™; Siri® Shortcut voice commands and automatic snore detection available
- Underbed LED nightlights
- Child-lock safety feature
- Headboard brackets and other leg sizes available upon request
- Upholstered in linen-inspired fabric
- 850-pound weight capacity on all sizes
- All sizes foldable for easy storage; Twin XL and Split California King can be shipped by FedEx and UPS
- Set up in 15 minutes from start to finish
- 20-year limited warranty guarantees high-quality construction

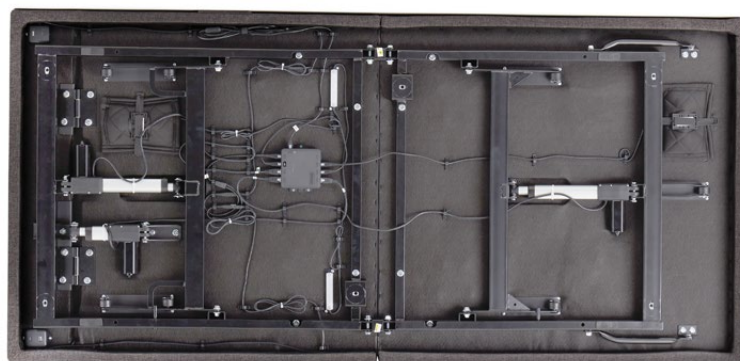

Adjustable Base

SIZE	SKU	PRICE
Twin XL	STMAS655TXAB	550.00
Split Queen	STMAS655SQAB	550.00
Split California King (Half)	STMAS655SCAB	550.00
Full	STMAS655FFAB	600.00
Queen	STMAS655QQAB	600.00
King	STMAS655KKAB	750.00

Accessories

SIZE	SKU	PRICE
Headboard Bracket Set	RP - NS01MODHBBX	20.00
Retainer Bar Cover POP	MA01STRBC	20.00

No MOQ

wrc.maloufhome.com | 800.517.7179 | www.maloufhome.com

23



BLUETOOTH®



APP

S755 SMART ADJUSTABLE BED BASE

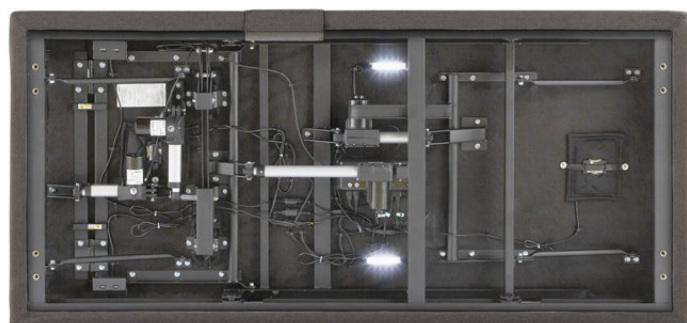

- Independent head incline: 0 – 60°, foot incline: 0 – 45°
- 15-inch floor to top of base height; includes 3" and 5" legs; modular legs available in additional sizes
- Motion-activated LED backlit wireless remote control, batteries included
- Five preset positions: Zero Gravity, Anti-Snore, Lounge, TV, and Flat
- Six programmable positions can be customized and saved
- True zero clearance; remove the legs to place directly on foundations, platform bases, slat beds, or ground
- One 5V 1A charging port and one 5V 2A charging port on the base
- Bluetooth® with the highest-rated and industry-leading Malouf Base App™; Siri® Shortcut voice commands and automatic snore detection available
- 12 dual-zone massage options: 4 types, 3 intensities with 3 time settings
- Underbed LED nightlights
- Child-lock safety feature
- Head tilt helps improve breathing and eliminate snoring
- Adjustable lumbar support allows you to find your perfect feel
- Reach Assist™ technology moves the bed back as it rises, allowing easy access to nightstand
- Headboard brackets available upon request
- Upholstered in linen-inspired fabric
- 850-pound weight capacity on all sizes
- Set up in 15 minutes from start to finish
- 20-year limited warranty guarantees high-quality construction

Adjustable Base

SIZE	SKU	PRICE
Twin XL	STMAS755TXAB	750.00
Split California King (Half)	STMAS755SCAB	750.00
Queen	STMAS755QQAB	800.00

Accessories

SIZE	SKU	PRICE
Headboard Bracket Set	RP-STABHBBRACKETS	20.00
Retainer Bar Cover POP	MA01STRBC	20.00



BLUETOOTH™



APP

No MOQ

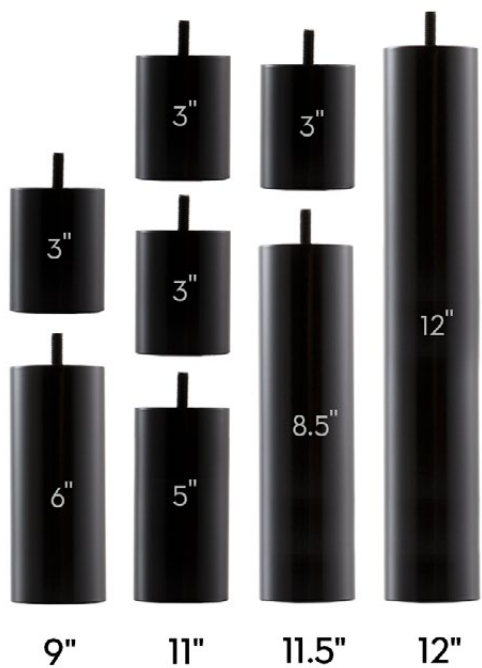
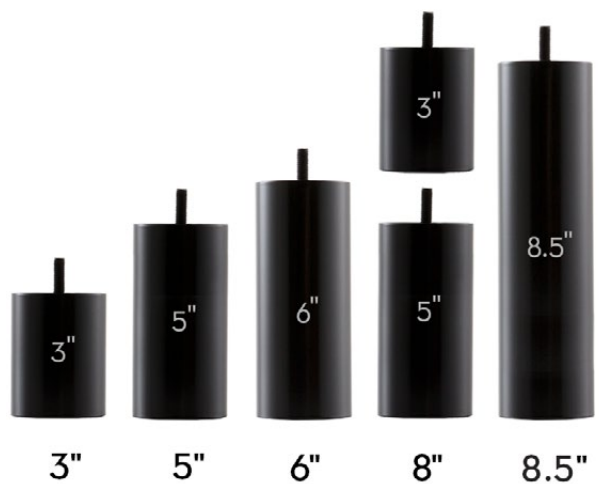

ADJUSTABLE LEGS

Leg adapters can be ordered to customize the height of all adjustable bases. Configurations should not exceed 12 inches or have more than 3 legs.

Set of 6 Legs (E255, E455, M455, M555, S655)

SIZE	SKU	PRICE
3 Inch	RP-STABNS03BKKDLEGS	25.00
5 Inch	RP-STABNS05BKKDLEGS	37.00
6 Inch	RP-STABNS06BKKDLEGS	37.00
8.5 Inch	RP-STABNS85BKKDLEGS	37.00
12 Inch	RP-NS6BKLEG12	37.00

Set of 4 Legs (S755)

SIZE	SKU	PRICE
3 Inch	RP-STABNS03BKLEGS	20.00
5 Inch	RP-STABNS05BKLEGS	25.00
6 Inch	RP-STABNS06BKLEGS	25.00
8.5 Inch	RP-STABNS85BKLEGS	25.00
12 Inch	RP-STABNS12BKLEGS	25.00

No MOQ



E255



E455



M455



M555



S655



S755

Remote	Wireless	Wireless	Wireless	Wireless	Wireless	Wireless
Warranty	10 Year	20 Year	20 Year	20 Year	20 Year	20 Year
Weight Capacity	750 lbs	850 lbs	850 lbs	850 lbs	850 lbs	850 lbs
Floor-to-Deck Height	15"	15"	15"	15"	15"	15"
Included Leg Height	12"	3" + 3" + 6"	3" + 3" + 6"	3" + 3" + 6"	3" + 3" + 6"	3" + 5"
Head Incline	●	●	●	●	●	●
Foot Incline	●	●	●	●	●	●
Quiet Motors	●	●	●	●	●	●
Ships via UPS	Twin XL, Split Cal King	Twin, Twin XL, Split Cal King	Twin XL, Split Queen, Split Cal King	Twin, Twin XL, Split Cal King, Split Queen	Twin XL, Split Cal King	
Memory Position(s)	2	2	1	5	6	6
Preset Position(s)	3	3	2	5	7	5
Zero Clearance	●	●	●	●	●	●
USB Ports		●	●	●	●	●
Malouf Base App™		●	●	●	●	●
Sync Cable Included		●	●	●	●	●
Massage			Single-Zone	Dual-Zone	Dual-Zone	Dual-Zone
LED Underbed Lights				●	●	●
Child Safety Lock				●	●	●
Head Tilt					●	●
Lumbar Support						●
Reach Assist™						●
Queen Price	\$350.00	\$425.00	\$475.00	\$550.00	\$600.00	\$800.00

MATTRESSES



NEW RELEASE



Now customers can truly meet all their sleep needs with Malouf®. Featuring unmistakable quality and innovative materials, Malouf mattresses are at the center of a complete sleep system designed to help your customers live well and sleep even better.



MALOUF



- COOLSYNC™ FOAM**  *Cool and contouring feel*
- ACTIVAIR™ FOAM**  *Responsive and plush feel*
- AEROFLEX™ LATEX**  *Supportive, quick-response feel*

- OMNIPHASE™ LAYER**  *Phase change material for continual temperature regulation*
- HYPERCHILL™ COVER**  *Instant cooling effect*

OUR PROPRIETARY MATERIALS

Great sleep starts with the right mattress, and with our wide assortment, your customers will find their perfect match.



ALL MALOUF™ MATTRESSES:



Foam is CertiPUR-US® certified to meet the highest standards



Compressed, rolled, and boxed for easy transportation



10-year non-prorated warranty



Assembled in the USA

NEVE

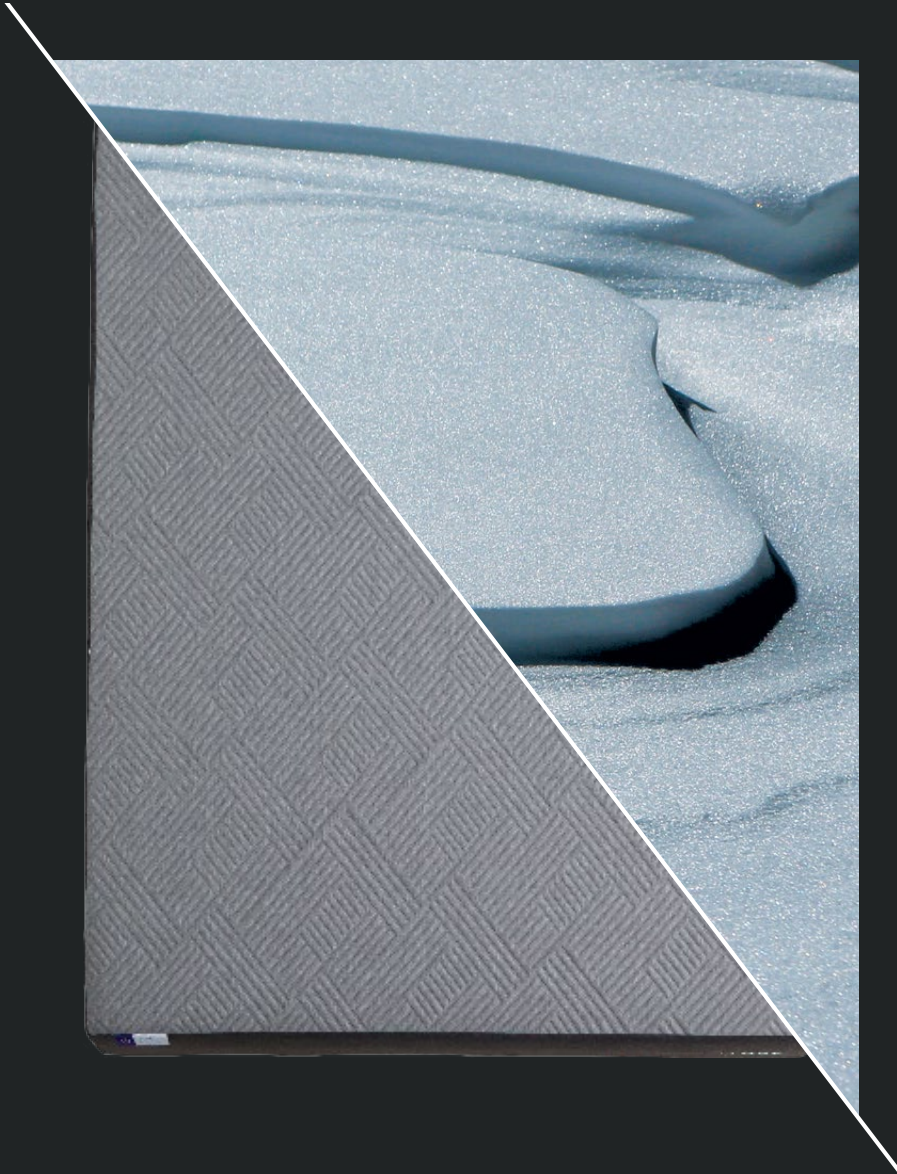

Start the Sleep Journey

High-quality all-foam mattresses made to support, contour, and cradle every curve. Multiple layers of soft foam offer incredible pressure relief, and the cooling gel infusion helps balance sleep temperature.



 10" CoolSync™



 12" ActivAir™



10" COOLSYNC™ ALL-FOAM MATTRESS

- Plush **CoolSync™ foam** gently contours to the body and balances sleep temperature with a cooling gel infusion design
- Bamboo charcoal transition foam helps remove excess moisture and maintain a fresh sleep environment
- Supportive base foam provides a stable foundation while remaining flexible for use with an adjustable bed base
- Soft-knit cover offers a comfortable sleep surface
- Foam is CertiPUR-US® certified to meet the highest standards
- Compressed, rolled, and boxed for easy transportation
- 10-year warranty
- Drop-ship ready
- Assembled in USA 



What's Inside

- 1 Soft-Knit Cover
- 2 2.5" CoolSync™ Memory Foam
- 3 1.5" Bamboo Charcoal Infused Foam
- 4 6" Supportive Base Foam

Neve 10" CoolSync™ All-Foam Mattress

SIZE	SKU	PRICE
Twin	MM10TTNE38GB	250.00
Twin XL	MM10TXNE38GB	275.00
Full	MM10FFNE38GB	350.00
Queen	MM10QQNE38GB	375.00
King	MM10KKNE38GB	475.00

No MOQ

wrc.maloufhome.com | 800.517.7179 | www.maloufhome.com



NEVE

12" ACTIVAIR™ ALL-FOAM MATTRESS

- Ultra-breathable **ActivAir™ foam** offers the bounce-back feel of latex with the contouring pressure relief of memory foam
- Plush **CoolSync™ foam** gently contours to the body and balances sleep temperature with a cooling gel infusion design
- Bamboo charcoal transition foam helps remove excess moisture and maintain a fresh sleep environment
- Supportive base foam provides a stable foundation while remaining flexible for use with an adjustable bed base
- Soft-knit cover offers a comfortable sleep surface
- Foam is CertiPUR-US® certified to meet the highest standards
- Compressed, rolled, and boxed for easy transportation
- 10-year warranty
- Drop-ship ready
- Assembled in USA 



What's Inside

- 1 Soft-Knit Cover
- 2 1" ActivAir™ Memory Foam
- 3 1.5" CoolSync™ Memory Foam
- 4 3" Bamboo Charcoal Infused Foam
- 5 6.5" Supportive Base Foam

Neve 12" ActivAir™ All-Foam Mattress

SIZE	SKU	PRICE
Twin	MM12TTNE40RB	325.00
Twin XL	MM12TXNE40RB	350.00
Full	MM12FFNE40RB	400.00
Queen	MM12QQNE40RB	450.00
King	MM12KKNE40RB	575.00
California King	MM12CKNE40RB	575.00

No MOQ

wzc.maloufhome.com | 800.517.7179 | www.maloufhome.com

POLARIS™

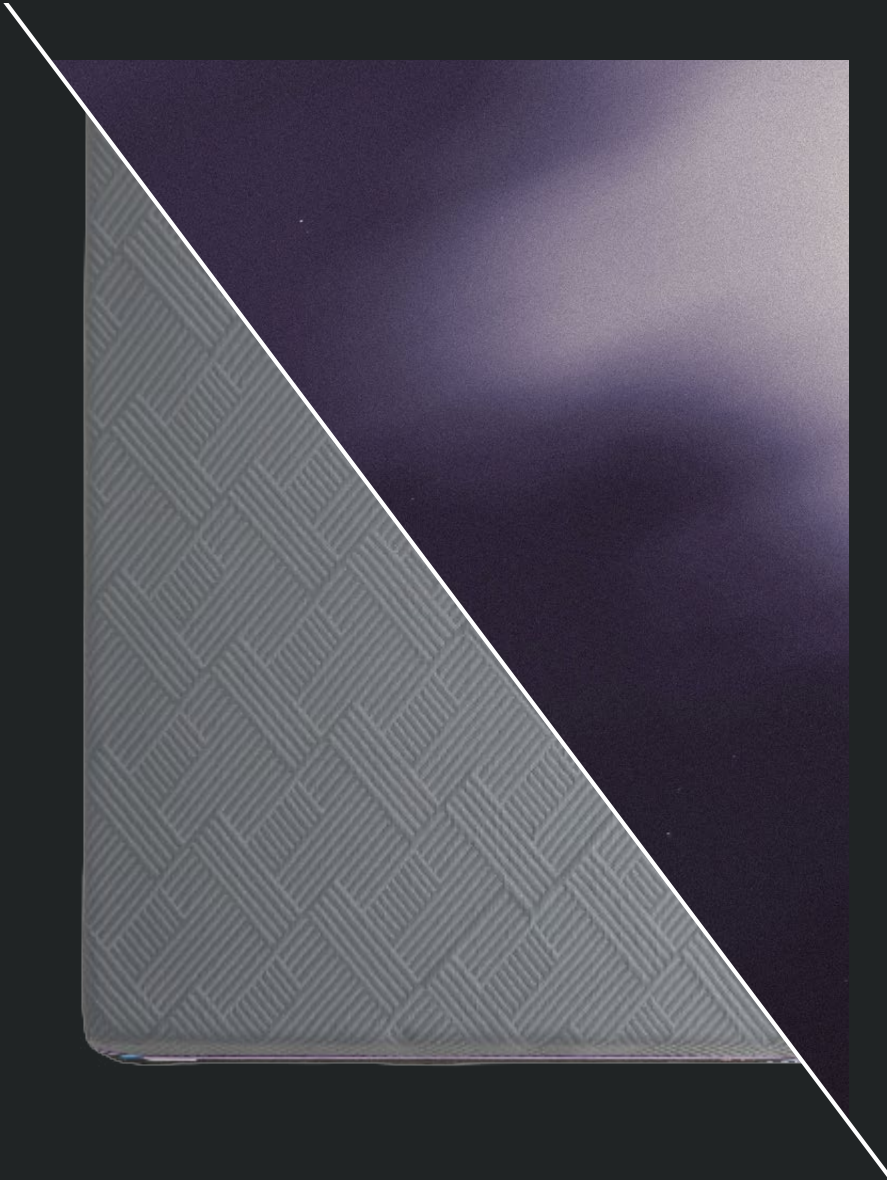

Elevate the Sleep Journey

Premium hybrid mattresses designed to offer upgraded support. A thick layer of individually encased steel coils plus your choice of plush CoolSync™ foam, quick-response ActivAir™ foam, or AeroFlex™ latex.



12" CoolSync™



12" ActivAir™

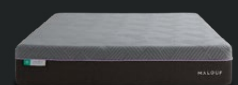

12" AeroFlex™



12" COOLSYNC™ HYBRID MATTRESS

- Plush **CoolSync™** foam gently contours to the body and balances sleep temperature with a cooling gel infusion design
- Bamboo charcoal transition foam helps remove excess moisture and maintain a fresh sleep environment
- Individually encased steel coils are zoned to offer specialized support to common pressure points
- Supportive base foam provides a stable foundation while remaining flexible for use with an adjustable bed base
- Soft cover with **HyperChill™ technology** offers an instantly cooling effect that contributes to rejuvenating sleep
- Foam is CertiPUR-US® certified to meet the highest standards
- Compressed, rolled, and boxed for easy transportation
- 10-year warranty
- Drop-ship ready
- Assembled in USA 🇺🇸



What's Inside

- 1 Soft HyperChill™ Cover
- 2 2" CoolSync™ Memory Foam
- 3 1" Bamboo Charcoal Infused Foam
- 4 8" Zoned Pocket Coils
- 5 1" Supportive Base Foam

ZONED SUPPORT

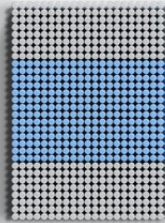

Polaris™ 12" CoolSync™ Hybrid Mattress

SIZE	SKU	PRICE
Twin	MM12TTP038GH	350.00
Twin XL	MM12TXP038GH	375.00
Full	MM12FFP038GH	450.00
Queen	MM12QQP038GH	500.00
King	MM12KKP038GH	625.00

No MOQ

wzc.maloufhome.com | 800.517.7179 | www.maloufhome.com



12" ACTIVAIR™ HYBRID MATTRESS

- Ultra-breathable **ActivAir™ foam** offers the bounce-back feel of latex with the contouring pressure relief of memory foam
- Plush **CoolSync™ foam** gently contours to the body and balances sleep temperature with a cooling gel infusion design
- Bamboo charcoal transition foam helps remove excess moisture and maintain a fresh sleep environment
- Individually encased steel coils are zoned to offer specialized support to common pressure points
- Supportive base foam provides a stable foundation while remaining flexible for use with an adjustable bed base
- Soft cover with **HyperChill™ technology** offers an instantly cooling effect that contributes to rejuvenating sleep
- Foam is CertiPUR-US® certified to meet the highest standards
- Compressed, rolled, and boxed for easy transportation
- 10-year warranty
- Drop-ship ready
- Assembled in USA 🇺🇸



What's Inside

- 1 Soft HyperChill™ Cover
- 2 2" ActivAir™ Foam
- 3 1" CoolSync™ Memory Foam
- 4 1" Bamboo Charcoal Infused Foam
- 5 6.3" Zoned Pocket Coils
- 6 1.7" Supportive Base Foam

ZONED SUPPORT

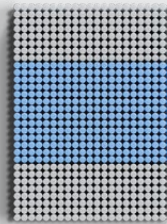

Polaris™ 12" ActivAir™ Hybrid Mattress

SIZE	SKU	PRICE
Twin	MM12TTP040RH	400.00
Twin XL	MM12TXP040RH	425.00
Full	MM12FFP040RH	500.00
Queen	MM12QQP040RH	550.00
King	MM12KKP040RH	675.00
California King	MM12CKP040RH	675.00

No MOQ



12" AEROFLEX™ HYBRID MATTRESS

- Eco-friendly **AeroFlex™ latex** sleeps slightly firmer than memory foam and offers superior breathability for refreshing rest
- Plush **CoolSync™ foam** gently contours to the body and balances sleep temperature with a cooling gel infusion
- Bamboo charcoal transition foam helps remove excess moisture and maintain a fresh sleep environment
- Individually encased steel coils are zoned to offer specialized support to common pressure points
- Supportive base foam provides a stable foundation while remaining flexible for use with an adjustable bed base
- Soft cover with **HyperChill™ technology** offers an instantly cooling effect that contributes to rejuvenating sleep
- Foam is CertiPUR-US® certified to meet the highest standards
- Compressed, rolled, and boxed for easy transportation
- 10-year warranty
- Drop-ship ready
- Assembled in USA 

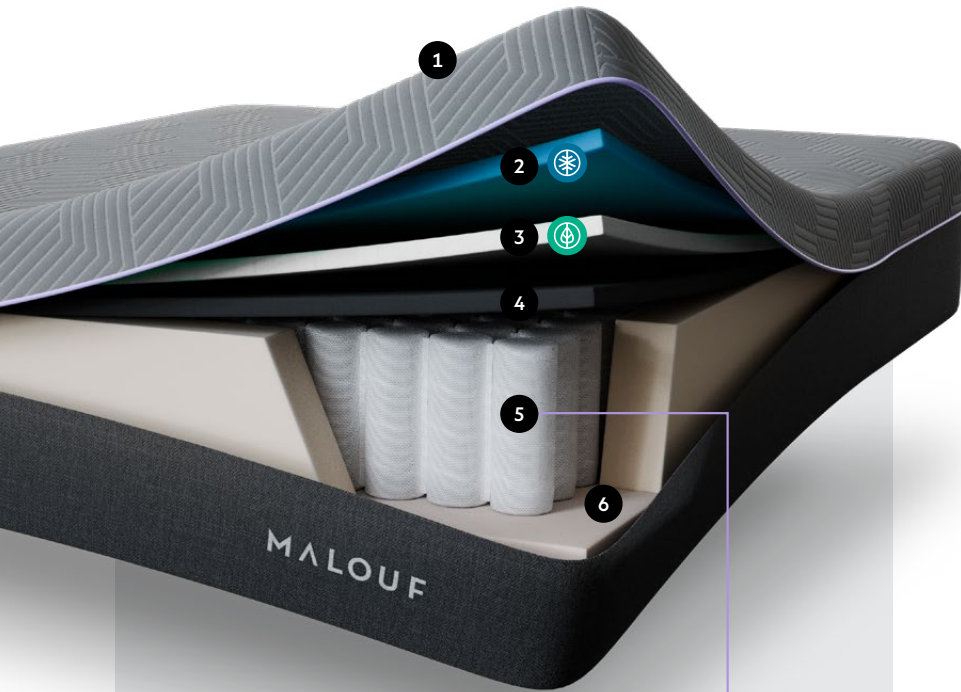

What's Inside

- 1 Soft HyperChill™ Cover
- 2 1" CoolSync™ Memory Foam
- 3 1" AeroFlex™ Latex
- 4 1" Bamboo Charcoal Infused Foam
- 5 8" Zoned Pocket Coils
- 6 1" Supportive Base Foam

ZONED SUPPORT

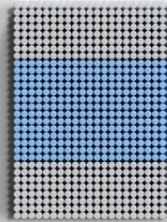

Polaris™ 12" AeroFlex™ Hybrid Mattress

SIZE	SKU	PRICE
Twin	MM12TTP070LH	475.00
Twin XL	MM12TXP070LH	500.00
Full	MM12FFP070LH	575.00
Queen	MM12QQP070LH	625.00
King	MM12KKP070LH	750.00
California King	MM12CKP070LH	750.00

No MOQ

wzc.maloufhome.com | 800.517.7179 | www.maloufhome.com

ICE CLOUD™

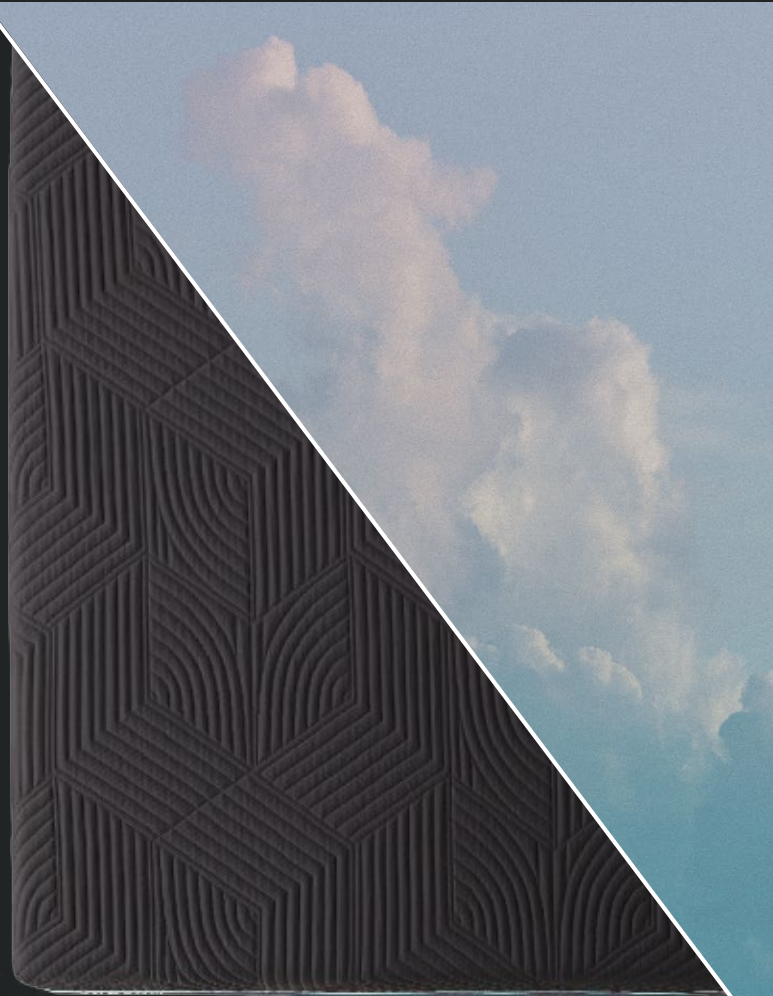
Fulfill the Sleep Journey **AND SLEEP 7° COOLER***

Premium hybrid mattresses that provide unmatched support and cooling. Each mattress is coated with a top layer of OmniPhase™ phase change material that actively absorbs and dissipates heat, which makes this mattress sleep 7 degrees cooler.*



14" CoolSync™



13" ActivAir™



14" AeroFlex™

*According to surface temperature testing done at the Malouf Research Center of an Ice Cloud™ mattress compared to a Malouf™ mattress without OmniPhase™ technology.

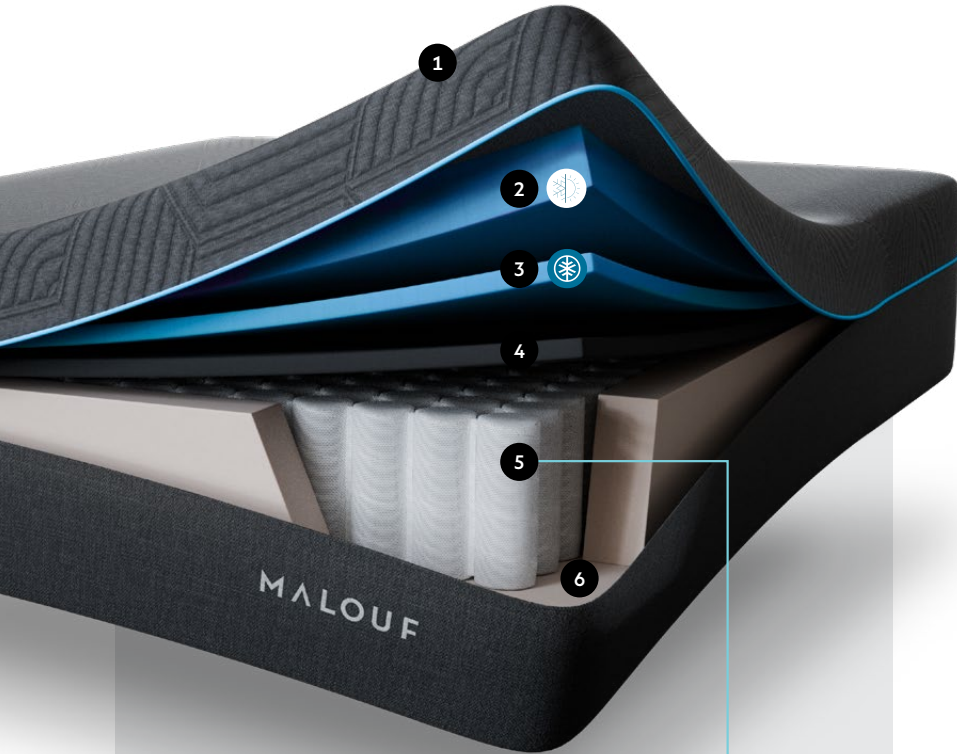

What's Inside

- 1 Soft HyperChill™ Cover
- 2 3" CoolSync™ Memory Foam + OmniPhase™ Phase Change Material
- 3 1" CoolSync™ Memory Foam
- 4 1" Bamboo Charcoal Infused Foam
- 5 8" Zoned Pocket Coils
- 6 1" Supportive Base Foam

ZONED SUPPORT

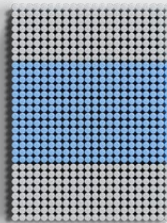

14" COOLSYNC™ HYBRID MATTRESS

- Plush **CoolSync™ foam** gently contours to the body and balances sleep temperature with a cooling gel infusion
- CoolSync™ foam is coated with **OmniPhase™ phase change technology** that actively absorbs and dissipates heat
- Bamboo charcoal transition foam helps remove excess moisture and maintain a fresh sleep environment
- Individually encased steel coils are zoned to offer specialized support to common pressure points
- Supportive base foam provides a stable foundation while remaining flexible for use with an adjustable bed base
- Soft cover with **HyperChill™ technology** offers an instantly cooling effect that contributes to rejuvenating sleep
- Foam is CertiPUR-US® certified to meet the highest standards
- Compressed, rolled, and boxed for easy transportation
- 10-year warranty
- Drop-ship ready
- Assembled in USA 🇺🇸

Ice Cloud™ 14" CoolSync™ Hybrid Mattress

SIZE	SKU	PRICE
Twin XL	MM14TXIC38GH	625.00
Full	MM14FFIC38GH	700.00
Queen	MM14QQIC38GH	750.00
King	MM14KKIC38GH	875.00
California King	MM14CKIC38GH	875.00

No MOQ

wrc.maloufhome.com | 800.517.7179 | www.maloufhome.com



What's Inside

- 1 Soft HyperChill™ Cover
- 2 2.5" ActivAir™ Memory Foam + OmniPhase™ Phase Change Material
- 3 1" CoolSync™ Memory Foam
- 4 1.2" Bamboo Charcoal Infused Foam
- 5 6.3" Zoned Pocket Coils
- 6 2" Supportive Base Foam

ZONED SUPPORT

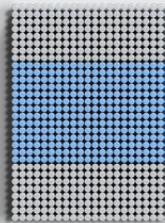

13" ACTIVAIR™ HYBRID MATTRESS

- Ultra-breathable **ActivAir™ foam** offers the bounce-back feel of latex with the contouring pressure relief of memory foam
- ActivAir™ foam is coated with **OmniPhase™ phase change technology** that actively absorbs and dissipates heat
- Plush **CoolSync™ foam** gently contours to the body and balances sleep temperature with a cooling gel infusion
- Bamboo charcoal transition foam helps remove excess moisture and maintain a fresh sleep environment
- Individually encased steel coils are zoned to offer specialized support to common pressure points
- Supportive base foam provides a stable foundation while remaining flexible for use with an adjustable bed base
- Soft cover with **HyperChill™ technology** offers an instantly cooling effect that contributes to rejuvenating sleep
- Foam is CertiPUR-US® certified to meet the highest standards
- Compressed, rolled, and boxed for easy transportation
- 10-year warranty
- Drop-ship ready
- Assembled in USA 🇺🇸

Ice Cloud™ 14" ActivAir™ Hybrid Mattress

SIZE	SKU	PRICE
Twin XL	MM13TXIC40RH	600.00
Full	MM13FFIC40RH	675.00
Queen	MM13QQIC40RH	725.00
King	MM13KKIC40RH	850.00
California King	MM13CKIC40RH	850.00

No MOQ

wrc.maloufhome.com | 800.517.7179 | www.maloufhome.com

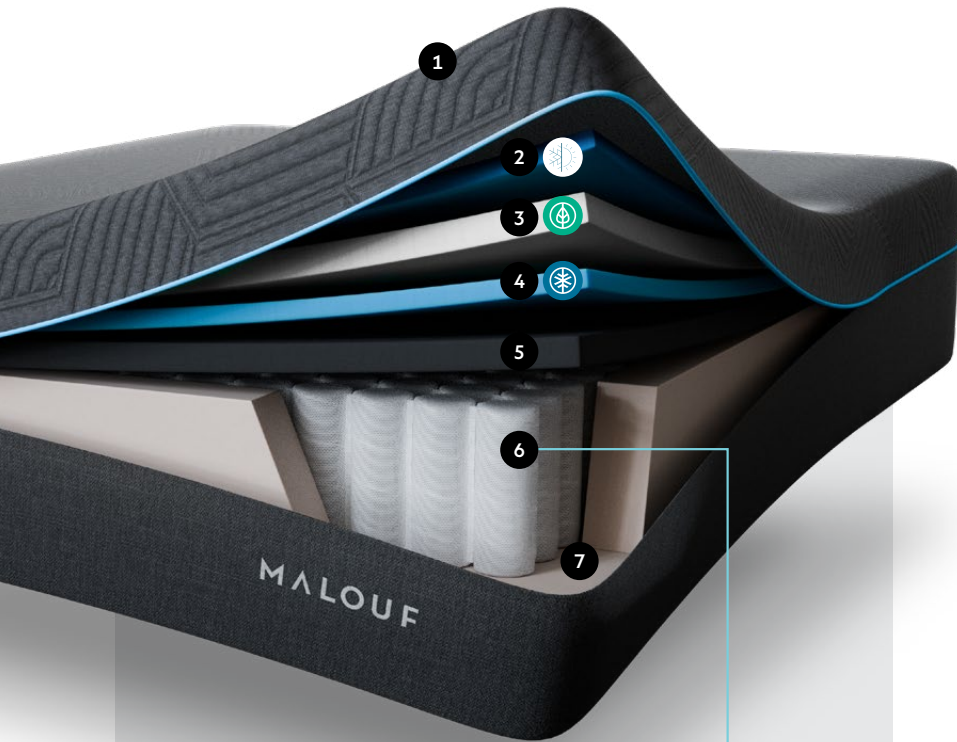

What's Inside

- 1 Soft HyperChill™ Cover
- 2 1" CoolSync™ Memory Foam + OmniPhase™ Phase Change Material
- 3 1.5" AeroFlex™ Latex
- 4 1" CoolSync™ Memory Foam
- 5 1.5" Bamboo Charcoal Infused Foam
- 6 8" Zoned Pocket Coils
- 7 1" Supportive Base Foam

ZONED SUPPORT

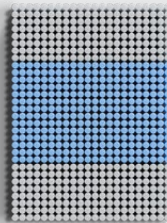

14" AEROFLEX™ HYBRID MATTRESS

- Eco-friendly **AeroFlex™ latex** sleeps slightly firmer than memory foam and offers superior breathability for refreshing rest
- **OmniPhase™ phase change technology** on top layer of foam actively absorbs and dissipates heat
- Plush **CoolSync™ foam** gently contours to the body and balances sleep temperature with a cooling gel infusion
- Bamboo charcoal transition foam helps remove excess moisture and maintain a fresh sleep environment
- Individually encased steel coils are zoned to offer specialized support to common pressure points
- Supportive base foam provides a stable foundation while remaining flexible for use with an adjustable bed base
- Soft cover with **HyperChill™ technology** offers an instantly cooling effect that contributes to rejuvenating sleep
- Foam is CertiPUR-US® certified to meet the highest standards
- Compressed, rolled, and boxed for easy transportation
- 10-year warranty
- Assembled in USA 🇺🇸

Ice Cloud™ 14" AeroFlex™ Hybrid Mattress









SIZE	SKU	PRICE
Twin XL	MM14TXIC70LH	650.00
Full	MM14FFIC70LH	725.00
Queen	MM14QQIC70LH	775.00
King	MM14KKIC70LH	950.00
California King	MM14CKIC70LH	950.00

No MOQ

wrc.maloufhome.com | 800.517.7179 | www.maloufhome.com

BUILD YOUR LINEUP

MALOUF™ MATTRESSES

		Profile	Feel	Drop-Ship Ready	Wholesale Price (Queen)	HyperChill™ Cooling Cover	Hybrid Design	Zoned Coils	OmniPhase™ Phase Change Materials	Warranty
NEVE	 with CoolSync™	10"	Medium Firm	●	\$375					10-Year Warranty
	 with ActivAir™	12"	Medium	●	\$450					10-Year Warranty
POLARIS™	 with CoolSync™	12"	Medium	●	\$500	●	●	●		10-Year Warranty
	 with ActivAir™	12"	Medium Plush	●	\$550	●	●	●		10-Year Warranty
	 with AeroFlex™	12"	Firm	●	\$625	●	●	●		10-Year Warranty
ICE CLOUD™	 with CoolSync™	14"	Medium Plush	●	\$750	●	●	●	●	10-Year Warranty
	 with ActivAir™	13"	Ultra Plush	●	\$725	●	●	●	●	10-Year Warranty
	 with AeroFlex™	14"	Medium		\$775	●	●	●	●	10-Year Warranty

FURNITURE

A woman with blonde hair is lying in a bed, looking towards the right. The bed has a light-colored, tufted headboard, white pillows, and a light blue duvet cover with a beige knitted blanket draped over it. The room features dark grey paneled walls, a wooden nightstand with books, a lamp with a white shade, and a wicker bench with a dark cushion. The floor is covered with a light-colored rug.

Bring classic style into your showroom with our timeless pieces and sell your customers a lifestyle. Add competitively priced furniture to your lineup of Malouf™ products, and it all ships together, helping ensure free freight on every order.

Upholstered HEADBOARDS

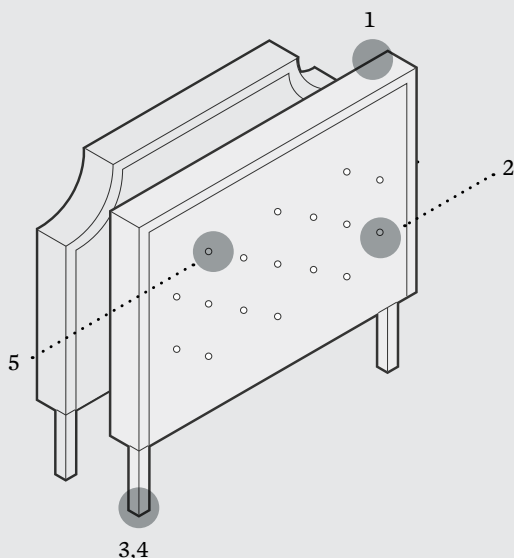

KEY FEATURES

- 1** **Finished Back**
includes a discrete compartment for storage
- 2** **Ultra-Plush Padding**
added comfort
- 3** **Adjustable Legs**
2-inch increments
- 4** **Easy Installation**
pre-drilled legs, modification plates, and wall mounts
- 5** **Buttonless Tufting**
geometric shape for clean, modern look

COLORS AND SKU CODES

● OA = Oat ● CH = Charcoal ● ST = Stone



- Select between rounded or square corners
- Legs adjust headboard height from 46 to 58 inches; mount directly to wall for any desired height
- Upholstered in 3 fabric options
- Pairs interchangeably with Malouf™ upholstered bases
- 15-year limited warranty guarantees high-quality construction

Hennessy (Square)

SIZE	SKU	PRICE
Queen	STQQ_HENHNB	120.00
King/California King	STKK_HENHNB	150.00

Carlisle (Rounded)

SIZE	SKU	PRICE
Queen	STQQ_CARLHB	120.00
King/California King	STKK_CARLHB	150.00

No MOQ

wzc.maloufhome.com | 800.517.7179 | www.maloufhome.com

Designer

HEADBOARDS

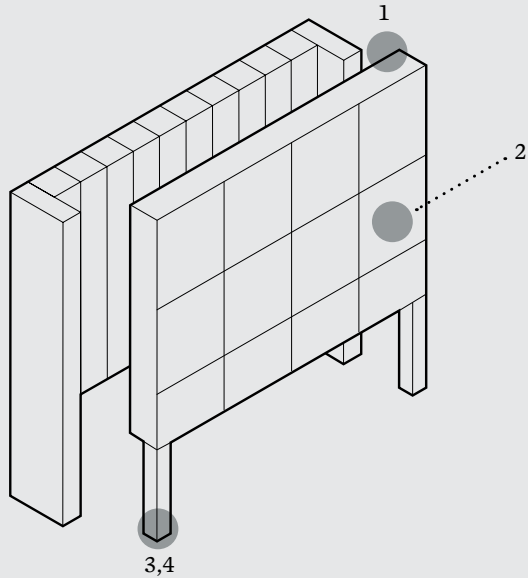

FURNITURE

- Select either designer option for an instant style upgrade
- Blackwell stands at 56.75 inches tall and is not adjustable, includes wings
- Scoresby adjusts from 49.5 to 61.5 inches; mount directly to wall for any desired height
- Upholstered in 3 fabric options
- Pairs interchangeably with Malouf® upholstered bases
- 15-year limited warranty guarantees high-quality construction

KEY FEATURES

- 1** **Finished Back**
includes a discrete compartment for storage
- 2** **Unique Plush Padding**
deep square tufting on the Scoresby and vertical channels on the Blackwell
- 3** **Statement Piece**
headboards are three feet tall with added leg height
- 4** **Easy Installation**
pre-drilled legs, modification plates, and wall mounts

Scoresby (Square Tufting)

SIZE	SKU	PRICE
Queen	STQQ_SCORHB	130.00
King/California King	STKK_SCORHB	160.00

Blackwell (Vertical Channels)

SIZE	SKU	PRICE
Queen	STQQ_BLWBHB	150.00
King/California King	STKK_BLWBHB	175.00

COLORS AND SKU CODES

● OA = Oat ● CH = Charcoal ● ST = Stone

No MOQ

wzc.maloufhome.com | 800.517.7179 | www.maloufhome.com

EASTMAN UPHOLSTERED BASE

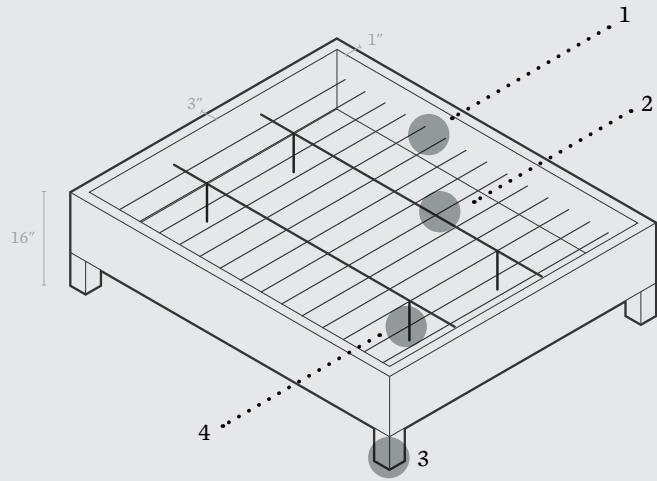

KEY FEATURES

- 1** Slat Roll
2.9-inch slat gap ensures compatibility with all industry mattress warranties
- 2** Center Bar(s)
create maximum support and comfort
- 3** Corner Legs
sleek wood finish
- 4** Additional Legs
provided with center bar for additional stability

COLORS AND SKU CODES

● OA = Oat ● CH = Charcoal ● ST = Stone



FURNITURE

- The Eastman is clean, elegant, and easy—perfect for customers who want a traditional platform bed
- Upholstered in 3 fabric options
- Compatible with all Malouf™ adjustable bases and most competitors
- Pairs interchangeably with Malouf™ headboards
- 15-year limited warranty guarantees high-quality construction
- Additional specifications on following pages

SIZE	SKU	PRICE
Queen	STQQ_EASTPL	175.00
King	STKK_EASTPL	200.00
California King	STCK_EASTPL	200.00

No MOQ

wzc.maloufhome.com | 800.517.7179 | www.maloufhome.com

WATSON UPHOLSTERED BASE

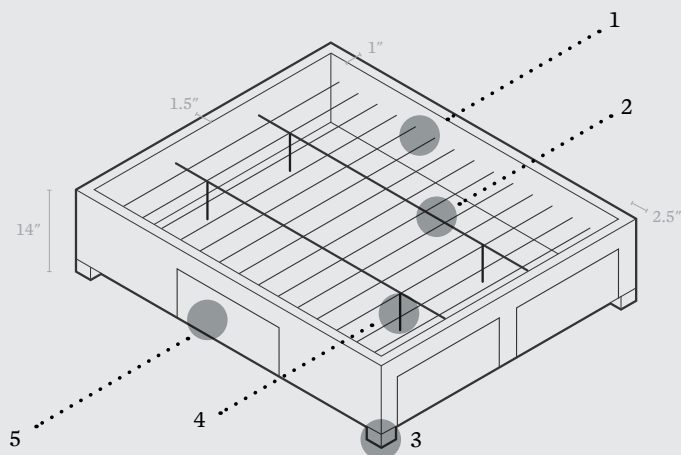

KEY FEATURES

- 1** **Slat Roll**
2.9-inch slat gap ensures compatibility with all industry mattress warranties
- 2** **Center Bar(s)**
create maximum support and comfort
- 3** **Corner Legs**
sleek wood finish
- 4** **Additional Legs**
provided with center bar for additional stability
- 5** **4 Drawers With Wheels**
Quick assembly and easy storage with caster wheels for hassle-free access

COLORS AND SKU CODES

● OA = Oat ● CH = Charcoal ● ST = Stone



- Four large underbed drawers maneuver easily on wheels and provide subtle storage
- Upholstered in 3 fabric options
- Compatible with zero-clearance adjustable bases
- Pairs interchangeably with Malouf™ headboards
- 15-year limited warranty guarantees high-quality construction
- Additional specifications on following pages

SIZE	SKU	PRICE
Queen	STQQ_WATSPL	275.00
King	STKK_WATSPL	325.00
California King	STCK_WATSPL	325.00

No MOQ

wzc.maloufhome.com | 800.517.7179 | www.maloufhome.com

SPECIFICATIONS

UPHOLSTERED BASES



FEATURE	EASTMAN	WATSON
Corner Leg Height	4"	2"
Floor to Top Rail Height	16"	14"
Underbed Clearance	4"	2"
Side Rail Thickness	1"	1"
Head Rail Thickness	3"	1.5"
Foot Rail Thickness	3"	2.5"
Center Support Bars	KK, CK: 2 QQ: 1	KK, CK: 2 QQ: 1
Slat Roll Size	QQ, KK, CK: 16-piece	QQ, KK, CK: 16-piece
Weight Capacity	800 lbs	800 lbs
Drawers	0	4
Side Drawer Dimensions	-	25.4" x 19.7" x 4.7"
Foot Drawer Dimensions	-	Queen 25.4" x 19.7" x 4.7" King 33.5" x 19.7" x 4.7" Cal King 31.4" x 19.7" x 4.7"

PROTECTORS

With our industry-leading and innovative options, Malouf™ mattress protectors solve a range of common customer problems and are an easy addition to any bedding purchase.

MATTRESS PAD

- Adds a layer of breathability and soft comfort
- Box-stitch quilting with down-alternative fill
- Hypoallergenic and dust mite resistant
- Fitted sheet design features Universal Fit™ elastic that ensures a secure fit for mattress depths 6 to 22 inches
- 5-year non-prorated warranty



Mattress Protector

Case packs of 4

SIZE	SKU	PRICE
Twin	SL0PTTPA	14.00
Twin XL	SL0PTXPA	15.00
Full	SL0PFFPA	16.00
Queen	SL0PQQPA	19.00
King	SL0PKKPA	23.00
Cal King	SL0PCKPA	23.00

Product packaging is updated throughout the year and may look different in your order.

No MOQ, no charge to split case packs

wrc.maloufhome.com | 800.517.7179 | www.maloufhome.com



PRIME™ COMFORT

- Formerly *Sleep Tite Prime™ Terry*
- Top of mattress protection
- Absorbent, hypoallergenic cotton terry sleeps comfortably and adds a cozy feel to the mattress
- Quiet and breathable laboratory-certified H2Pro™ membrane is liquid proof and dust mite proof
- Fitted sheet design features Universal Fit™ elastic that ensures a secure fit for mattress depths 6 to 22 inches
- 15-year non-prorated protector and mattress warranty when purchased on the same receipt

Mattress Protector

Case packs of 8

SIZE	SKU	PRICE
Crib	SL00CRMP	14.00
Cot	SL00CTMP	14.00
Twin	SL00TTMP	15.00
Twin XL	SL00TXMP	17.00
Full	SL00FFMP	18.00
Full XL	SL00FXMP	18.00
Queen	SL00QQMP	19.00
Olympic Queen	SL00OQMP	22.00
King	SL00KKMP	22.00
California King	SL00CKMP	23.00
Split Queen (2 Pieces)	SL00SQMP	24.00
Split King (2 Pieces)	SL00SKMP	25.00
Split California King (2 Pieces)	SL00SCMP	25.00

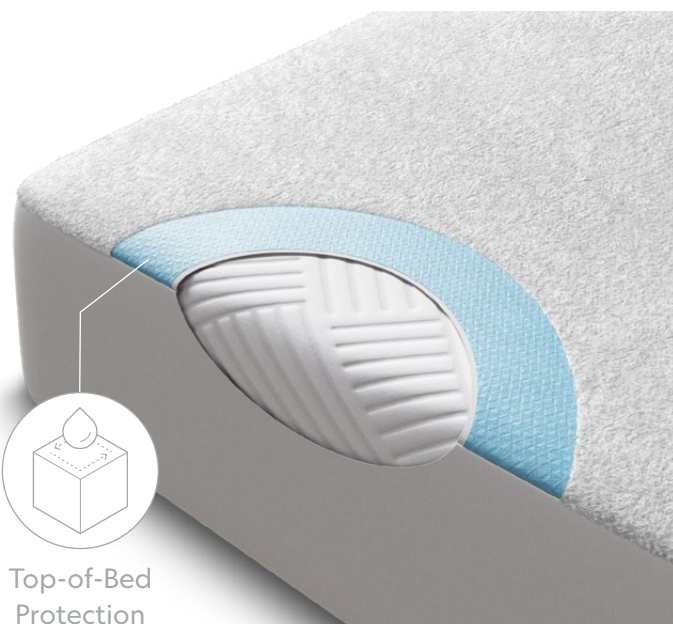

Top-of-Bed
Protection

Product packaging is updated throughout the year and may look different in your order.

No MOQ, no charge to split case packs

wrc.maloufhome.com | 800.517.7179 | www.maloufhome.com

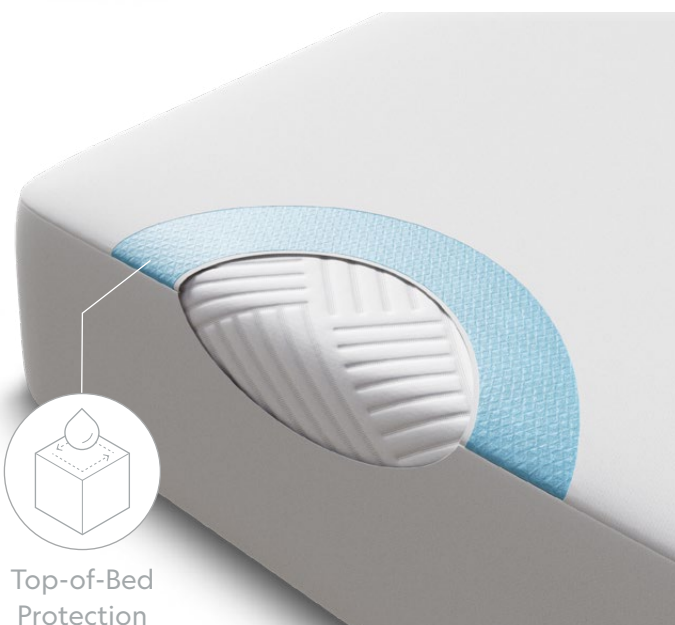

Top-of-Bed
Protection

PRIME

- Formerly *Sleep Tite PrIme™ Smooth*
- Top of mattress protection
- Lightweight, hypoallergenic fabric sleeps comfortably without changing the feel of the mattress
- Quiet and breathable laboratory-certified H2Pro™ membrane is liquid proof and dust mite proof
- Fitted sheet design features Universal Fit™ elastic that ensures a secure fit for mattress depths 6 to 22 inches
- 15-year non-prorated protector and mattress warranty when purchased on the same receipt

Mattress Protector

Case packs of 8

SIZE	SKU	PRICE
Twin	SL0PTTMP	14.00
Twin XL	SL0PTXMP	16.00
Full	SL0PFFMP	17.00
Queen	SL0PQQMP	18.00
King	SL0PKKMP	21.00
California King	SL0PCKMP	22.00
Split Queen (2 Pieces)	SL0PSQMP	23.00
Split King (2 Pieces)	SL0PSKMP	23.00
Split California King (2 Pieces)	SL0PSCMP	23.00
Split Head Queen	SL0PYQMP	23.00
Split Head King	SL0PYKMP	26.00
Split Head California King	SL0PYCMP	26.00

Pillow Protector

Case packs of 8

SIZE	SKU	PRICE
Queen (Set of 2)	SL0PQQPP	15.00
King (Set of 2)	SL0PKKPP	17.00

Product packaging is updated throughout the year and may look different in your order.

No MOQ, no charge to split case packs

wrc.maloufhome.com | 800.517.7179 | www.maloufhome.com

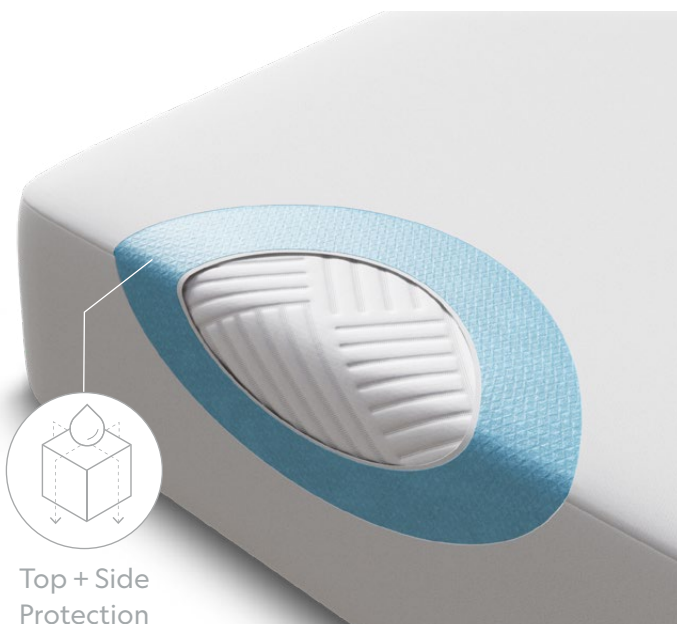

Top + Side
Protection

FIVE SIDED™

- Formerly *Sleep Tite Five Sided™ Smooth*
- Top and side mattress protection
- Plush, hypoallergenic fabric sleeps comfortably without changing the feel of the mattress
- Quiet and breathable laboratory-certified H2Pro™ membrane is liquid proof and dust mite proof
- Fitted sheet design features Universal Fit™ elastic that ensures a secure fit for mattress depths 6 to 22 inches
- 15-year non-prorated protector and mattress warranty when purchased on the same receipt

Mattress Protector

Case packs of 8

SIZE	SKU	PRICE
Twin	SL0PTT5P	22.00
Twin XL	SL0PTX5P	23.00
Full	SL0PFF5P	25.00
Queen	SL0PQQ5P	27.00
King	SL0PKK5P	31.00
California King	SL0PCK5P	33.00
Split Queen (2 Pieces)	SL0PSQ5P	34.00
Split King (2 Pieces)	SL0PSK5P	36.00
Split California King (2 Pieces)	SL0PSC5P	36.00

Product packaging is updated throughout the year and may look different in your order.

No MOQ, no charge to split case packs

wrc.maloufhome.com | 800.517.7179 | www.maloufhome.com

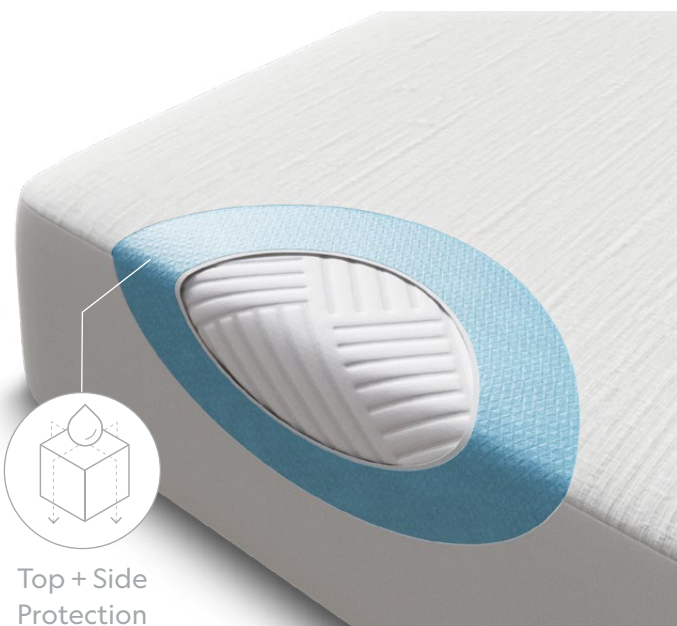

FIVE SIDED™ + OMNIPHASE™

- Formerly *Sleep Tite Five Sided™ OmniPhase™*
- Top and side mattress protection
- OmniPhase™ phase change material actively regulates temperature by absorbing and dissipating heat
- Known for superior moisture-management properties, TENCEL™ Lyocell fiber aids in optimal sleeping temperatures
- Proprietary fabric combination provides all-season comfort
- Quiet and breathable laboratory-certified H2Pro™ membrane is liquid proof and dust mite proof
- Fitted sheet design features Universal Fit™ elastic that ensures a secure fit for mattress depths 6 to 22 inches
- 15-year non-prorated protector and mattress warranty when purchased on the same receipt

Mattress Protector

Case packs of 8

SIZE	SKU	PRICE
Twin	SL0TTT5P	27.00
Twin XL	SL0TTX5P	29.00
Full	SL0TFF5P	34.00
Queen	SL0TQ05P	37.00
King	SL0TKK5P	40.00
California King	SL0TCK5P	41.00
Split Queen (2 Pieces)	SL0TSQ5P	41.00
Split King (2 Pieces)	SL0TSK5P	46.00
Split California King (2 Pieces)	SL0TSC5P	46.00
Split Head Queen	SL0TYQ5P	46.00
Split Head King	SL0TYK5P	52.00
Split Head California King	SL0TYC5P	52.00

Product packaging is updated throughout the year and may look different in your order.

No MOQ, no charge to split case packs

wrc.maloufhome.com | 800.517.7179 | www.maloufhome.com

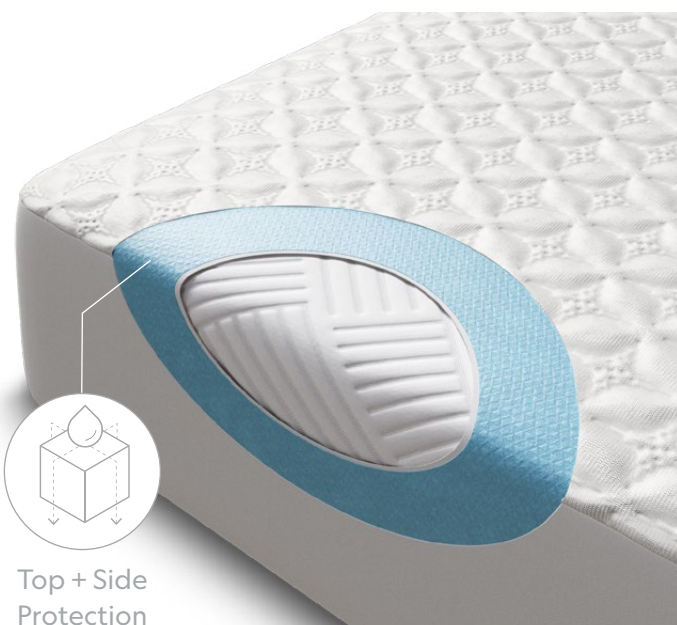

Top + Side
Protection

FIVE SIDED™ + HYPERCHILL™

- Formerly *Sleep Tite Five Sided™ IceTech™*
- Top and side mattress protection
- HyperChill™ fabric is cool to the touch for an instant cooling effect
- Quiet and breathable laboratory-certified H2Pro™ membrane is liquid proof and dust mite proof
- Fitted sheet design features Universal Fit™ elastic that ensures a secure fit for mattress depths 6 to 22 inches
- 15-year non-prorated protector and mattress warranty when purchased on the same receipt

Mattress Protector

Case packs of 4

SIZE	SKU	PRICE
Twin	SLICTT5P	55.00
Twin XL	SLICTX5P	60.00
Full	SLICFF5P	68.00
Queen	SLICQQ5P	70.00
King	SLICKK5P	90.00
California King	SLICCK5P	90.00
Split Queen (2 Pieces)	SLICSQ5P	90.00
Split King (2 Pieces)	SLICKS5P	100.00
Split California King (2 Pieces)	SLICSC5P	100.00
Split Head Queen	SLICYQ5P	100.00
Split Head King	SLICYK5P	115.00
Split Head California King	SLICYC5P	115.00

Pillow Protector

Case packs of 12

SIZE	SKU	PRICE
Queen (Set of 2)	SLICQP5	40.00
King (Set of 2)	SLICKP5	50.00

Product packaging is updated throughout the year and may look different in your order.

No MOQ, no charge to split case packs

wrc.maloufhome.com | 800.517.7179 | www.maloufhome.com



ENCASE™ 360°

- Formerly *Sleep Tite Encase™ HD*
- Patented complete encasement mattress protection
- Laboratory-certified Micro Tite™ 360° zipper closure blocks bed bugs; easily removable for laundering
- Quiet and breathable laboratory-certified H2Pro™ membrane is liquid proof and dust mite proof
- Universal Fit™ inner elastic along bottom guarantees a smooth, secure fit for mattress depths 6 to 22 inches
- 15-year non-prorated protector and mattress warranty when purchased on the same receipt

Mattress Protector

Case packs of 8

SIZE	SKU	PRICE
Twin	SL0PTTEP	29.00
Twin XL	SL0PTXEP	31.00
Full	SL0PFFEP	36.00
Queen	SL0PQQEP	39.00
King	SL0PKKEP	42.00
California King	SL0PCKEP	33.00
Split Queen (2 Pieces)	SL0PSQEP	43.00
Split King (2 Pieces)	SL0PSKEP	48.00
Split California King (2 Pieces)	SL0PSCEP	48.00



Complete 360°
Protection

Product packaging is updated throughout the year and may look different in your order.

No MOQ, no charge to split case packs

wrc.maloufhome.com | 800.517.7179 | www.maloufhome.com



Mattress Pad



Prime™ Comfort



Prime™



Five Sided™



Five Sided™ OmniPhase™



Five Sided™ HyperChill™



Encase™ 360

	Mattress Pad	Prime™ Comfort	Prime™	Five Sided™	Five Sided™ OmniPhase™	Five Sided™ HyperChill™	Encase™ 360
Mattress Depth	6-22"	6-22"	6-22"	6-22"	6-22"	6-22"	6-22"
Warranty	5 Year	15 Year	15 Year	15 Year	15 Year	15 Year	15 Year
Laboratory-Certified H2Pro™ Liquid-Proof Membrane		●	●	●	●	●	●
Dust Mite Protection	●	●	●	●	●	●	●
Universal Fit™ Elastic	●	●	●	●	●	●	●
Laboratory-Certified Micro Tite 360 Zipper							●
Cooling					●	●	
Bed Bug Protection							●
Queen Price	\$19.00	\$19.00	\$18.00	\$27.00	\$37.00	\$70.00	\$39.00
Protection	Top of Mattress			Top and Sides of Mattress			Complete Encasement

PROTECTORS

BEDDING



Malouf™ linens and comforters offer a selection of premium fabrics and fills in a variety of price points and colors. Improve your attachment rates with accessories designed for every customer budget.

SOFT-KNIT MICROFIBER



- Super soft, double-brushed microfiber
- Naturally stain and wrinkle resistant
- Universal Fit™ elastic and extra-deep pockets ensure a secure fit for mattress depths 6 to 14 inches
- Sheet set includes pillowcase(s)
- New packaging allows for touchable fabric and uses 66% less plastic
- 3-year limited warranty guarantees high-quality construction

Sheet Set

Case packs of 4

SIZE	SKU	PRICE
Cot*	MA90CTWHMS	17.00
Twin	MA90TT_MS	18.00
Twin XL	MA90TX_MS	19.00
Full	MA90FF_MS	21.00
Short Queen*	MA90RQWHMS	23.00
Queen	MA90QQ_MS	23.00
King	MA90KK_MS	26.00
California King	MA90CK_MS	27.00
Split Queen*	MA90SQWHMS	27.00
Split King	MA90SK_MS	29.00
Split California King*	MA90SCWHMS	30.00

Pillowcase Set

Case packs of 8

SIZE	SKU	PRICE
Standard (Set of 2)*	MA90ST_PC	9.00
Queen (Set of 2)	MA90QQ_PC	10.00
King (Set of 2)	MA90KK_PC	12.00

Colors and SKU Codes

- WH = White
 DR = Driftwood
 AS = Ash
 PA = Pacific
- BH = Blush (*Twin, Full only*)

No MOQ, no charge to split case packs | *Available in White only

wrc.maloufhome.com | 800.517.7179 | www.maloufhome.com

CLASSIC COTTON

- Made from 100% cotton
- Natural cotton fibers are soft and gentle on the skin
- Open percale weave creates crisp, breathable feel
- Oversized dimensions for a beautiful drape and fit
- Universal Fit™ elastic and extra-deep pockets provide secure fit for mattress depths 6 to 14 inches
- New packaging uses 66% less plastic and allows customers to touch and feel the fabric
- Sheet set includes pillowcase(s)
- 3-year limited warranty guarantees high-quality construction
- Available end of Q3



Sheet Set

Case packs of 4

SIZE	SKU	PRICE
Twin	MA02TT_CS	34.00
Twin XL	MA02TX_CS	36.00
Full	MA02FF_CS	38.00
Queen	MA02QQ_CS	40.00
King	MA02KK_CS	47.00
California King	MA02CK_CS	47.00
Split Queen	MA02SQ_CS	50.00
Split Head Queen	MA02YQ_CS	50.00
Split King	MA02SK_CS	55.00
Split Head King	MA02YK_CS	55.00
Split California King	MA02SC_CS	55.00
Split Head California King	MA02YC_CS	55.00

Pillowcase Set

Case packs of 8

SIZE	SKU	PRICE
Queen (Set of 2)	MA02QQ_CC	11.00
King (Set of 2)	MA02KK_CC	12.00

Colors and SKU Codes

WH = White
 CR = Cream
 CH = Charcoal
 MR = Marine

No MOQ, no charge to split case packs

wrc.maloufhome.com | 800.517.7179 | www.maloufhome.com

LINEN-WEAVE COTTON



- Casual, linen-like look made from 100 percent cotton
- Open percale weave is light and airy for extra breathable feel
- Cotton fibers are soft, strong, and naturally hypoallergenic
- Oversized dimensions provide relaxed, luxurious drape
- Universal Fit™ elastic and extra-deep pockets provide secure fit for mattress depths 6 to 14 inches
- New packaging uses 66% less plastic and allows customers to touch and feel the fabric
- Sheet set includes pillowcase(s)
- 3-year limited warranty guarantees high-quality construction

Sheet Set

Case packs of 4

SIZE	SKU	PRICE
Twin	MA12TT_CS	44.00
Twin XL	MA12TX_CS	45.00
Full	MA12FF_CS	46.00
Queen	MA12QQ_CS	49.00
King	MA12KK_CS	54.00
California King	MA12CK_CS	54.00
Split Queen*	MA12SQWHCS	64.00
Split King	MA12SK_CS	67.00
Split California King*	MA12SCWHCS	67.00

Pillowcase Set

Case packs of 8

SIZE	SKU	PRICE
Queen (Set of 2)	MA12QQ_CC	15.00
King (Set of 2)	MA12KK_CC	17.00

Colors and SKU Codes

WH = White
 FG = Fog
 SA = Sand
 SG = Sage

No MOQ, no charge to split case packs | *Available in White only

www.maloufhome.com | 800.517.7179 | www.maloufhome.com

SMOOTH BAMBOO RAYON



- Smooth, round fibers are hypoallergenic, and ideal for sensitive skin
- Fibers help wick away moisture from the skin to keep you cool in summer and warm in winter
- Oversized dimensions and will weave allow for a lovely drape
- Universal Fit™ ultra-thick elastic and extra-deep pockets ensure a secure fit for mattress depths 6 to 18 inches
- New packaging allows for touchable fabric and uses 66% less plastic
- Sheet set includes pillowcase(s)
- 5-year limited warranty guarantees high-quality construction

Sheet Set

Case packs of 4

SIZE	SKU	PRICE
Twin*	MA25TTWHBS	55.00
Twin XL*	MA25TXWHBS	57.00
Full*	MA25FFWHBS	62.00
Queen	MA25QQ_BS	65.00
King	MA25KK_BS	70.00
California King	MA25CK_BS	71.00
Split Queen*	MA25SQWHBS	80.00
Split Head Queen**	MA25QWHBS	80.00
Split King	MA25SK_BS	85.00
Split California King*	MA25SCWHBS	85.00
Split Head King**	MA25KWHBS	85.00
Split Head California King*	MA25CWHBS	85.00

Pillowcase Set

Case packs of 8

SIZE	SKU	PRICE
Queen (Set of 2)	MA25QQ_BC	18.00
King (Set of 2)	MA25KK_BC	20.00

Colors and SKU Codes

WH = White
 RA = Rain
 DR = Driftwood
 AS = Ash

No MOQ, no charge to split case packs | *Available in White Only | **Available in White & Ash Only

wrc.maloufhome.com | 800.517.7179 | www.maloufhome.com

BOTANICAL

SHEET SET WITH TENCEL™ LYOCELL FIBER



- 100 percent Tencel™ Lyocell fibers
- Made from eco-friendly, renewable botanical fiber in a closed-loop system
- Superior moisture management properties aid in cooler sleeping temperatures
- Unparalleled soft touch with a lustrous sateen weave
- Oversized dimensions allow for a lovely drape and fit
- Universal Fit™ ultra-thick elastic and extra-deep pockets ensure a secure fit for mattress depths 6 to 18 inches
- New packaging uses 66% less plastic and allows customers to touch and feel the fabric
- Sheet set includes pillowcase(s)
- 5-year limited warranty guarantees high-quality construction

Sheet Set

Case packs of 4

SIZE	SKU	PRICE
Twin*	MA03TTWHTS	55.00
Twin XL*	MA03TXWHTS	57.00
Full*	MA03FFWHTS	62.00
Queen	MA03QQ_TS	65.00
King	MA03KK_TS	70.00
California King	MA03CK_TS	71.00
Split Queen*	MA03SQWHTS	80.00
Split King	MA03SK_TS	85.00
Split California King*	MA03SCWHTS	85.00

Pillowcase Set

Case packs of 8

SIZE	SKU	PRICE
Queen (Set of 2)	MA03QQ_TC	18.00
King (Set of 2)	MA03KK_TC	20.00

Colors and SKU Codes

- WH = White
 OP = Opal
 DU = Dusk
 EC = Ecu

No MOQ, no charge to split case packs | *Available in White Only

wrc.maloufhome.com | 800.517.7179 | www.maloufhome.com

NATURAL SUPIMA® COTTON



- 100% American-grown, extra-long staple Supima® cotton
- Single-ply, 600-thread-count sheets feature a luxurious sateen weave
- Breathable and remarkably pill resistant; mercerized for softer, more vibrant color
- Universal Fit™ ultra-thick elastic and extra-deep pockets ensure a secure fit for mattress depths 6 to 18 inches
- Branded Supima® fiber cannot be imitated or falsely advertised
- New packaging uses 66% less plastic and allows customers to touch and feel the fabric
- Oversized dimensions allow for a lovely drape and fit
- Sheet set includes pillowcase(s)
- 5-year limited warranty guarantees high-quality construction

Sheet Set

Case packs of 4

SIZE	SKU	PRICE
Twin*	MAS6TTWHSS	85.00
Twin XL*	MAS6TXWHSS	90.00
Full*	MAS6FFWHSS	95.00
Queen	MAS6QQ_SS	100.00
King	MAS6KK_SS	125.00
California King	MAS6CK_SS	125.00
Split Queen*	MAS6SQWHSS	113.00
Split King	MAS6SK_SS	150.00
Split California King*	MAS6SCWHSS	150.00

Pillowcase Set

Case packs of 8

SIZE	SKU	PRICE
Queen (Set of 2)	MAS6QQ_PC	22.00
King (Set of 2)	MAS6KK_PC	24.00

Colors and SKU Codes

○ WH = White ● SM = Smoke ● CC = Charcoal

No MOQ, no charge to split case packs | *Available in White Only

wrc.maloufhome.com | 800.517.7179 | www.maloufhome.com

BED IN A BAG



- Includes reversible down-alternative comforter, down-alternative pillow(s), and a brushed microfiber sheet set
- Super-soft, stain, and wrinkle resistant white sheet set includes flat sheet, fitted sheet(s), and pillowcase(s)
- Pillows feature luxurious down feel without odors, allergens, or sharp quills
- Featuring patented Duv8t™ Fastening System with 8 side and corner loops to secure your duvet cover without bunching
- 3-year limited warranty guarantees high-quality construction

Bed in a Bag Set

Case packs of 2

SIZE	SKU	PRICE
Twin	MA01TT_BB	50.00
Twin XL	MA01TX_BB	55.00
Full	MA01FF_BB	65.00
Queen	MA01QQ_BB	70.00
King	MA01KK_BB	85.00
California King*	MA01CKWHBB	90.00

Colors and SKU Codes

○ WHWH = White ● PAAS = Pacific/Ash



No MOQ, no charge to split case packs | *Available in White only

wrc.maloufhome.com | 800.517.7179 | www.maloufhome.com

PILLOWS



Our comprehensive Malouf® pillow line creates levels of comfort and personalization for every customer. Our sales reps work with you to create the perfect program for your unique client base.

GELLED MICROFIBER™



- Filled with gel-coated microfiber that doesn't shift or clump
- Luxurious down feel without odors, allergens, or sharp quills
- 250-thread-count pure cotton percale cover offers a crisp, clean, and breathable pillow surface
- 3-year limited warranty guarantees high-quality construction

Pillow

Case packs of 4

SIZE	SKU	PRICE
Queen	ZZQQ00GM	18.00
King	ZZKK00GM	22.00



No MOQ, no charge to split case packs

wzc.maloufhome.com

800.517.7179

www.maloufhome.com

109



CONVOLUTION™

- Removable, convoluted memory foam core encased in Gelled Microfiber™ fill
- 3 levels of customizable support to accommodate all sleeping positions
- Luxurious down feel without odors, allergens, or sharp quills
- 3-year limited warranty guarantees high-quality construction

Convolution™

- Dough™ memory foam core
- Crisp, breathable 300-thread-count pure cotton damask stripe cover features sophisticated piping

Case packs of 4

SIZE	SKU	PRICE
Queen	ZZQQX2CG	26.00
King	ZZKKX2CG	30.00

Gel Convolution™

- Gel Dough™ memory foam core
- Tencel™ Lyocell cover with superior moisture-management properties aids in optimal sleeping temperatures

Case packs of 4

SIZE	SKU	PRICE
Queen	ZZQQHPCOGF	37.00
King	ZZKKHPCOGF	42.00

No MOQ, no charge to split case packs



FLEXFILL™ + HYPERCHILL™

- Shredded memory foam and down alternative fiber blend
- Flexible shape offers versatile support
- HyperChill™ cover is cool to the touch
- 3-year limited warranty guarantees high-quality construction
- **Shoulder cutout** shape ideal for side sleepers

Pillow		Case packs of 4
SIZE	SKU	PRICE
Queen	ZZQQPEHFSD	32.00
King	ZZKKPEHFSD	37.00



Shoulder Pillow		Case packs of 4
SIZE	SKU	PRICE
Queen	ZZQQSCPEHFSD	32.00
King	ZZKKSCPEHFSD	37.00



Shoulder

No MOQ, no charge to split case packs

TRIPLELAYER™ DOWN



- Luxuriously soft, supportive, and natural
- 90% down top and bottom layer
- 90% feather supportive inner core
- 100% natural unbleached, undyed cotton cover
- Breathable percale weave cover
- Ethically harvested down clusters and feathers
- Self-fabric packaging looks gorgeous on shelves
- 3-year limited warranty guarantees high-quality construction

Pillow

Case packs of 6

SIZE	SKU	PRICE
Queen	ZZQQ3L90DD	50.00
King	ZZKK3L90DD	55.00



No MOQ, no charge to split case packs

wzc.maloufhome.com

800.517.7179

www.maloufhome.com

115

ZONED DOUGH™ + BAMBOO CHARCOAL

- Infused with bamboo charcoal to help regulate humidity, temperature, and odors
- Zoned Technology™ design cradles the head while supporting the neck
- Ventilated for increased airflow and breathability
- Dough™ formula creates a softer, more supportive memory foam
- Tencel™ Lyocell removable cover with superior moisture-management properties aids in optimal sleeping temperatures
- 5-year limited warranty guarantees high-quality construction
- **Shoulder cutout** shape ideal for side sleepers



Mid Loft Pillow

Case packs of 4

SIZE	SKU	PRICE
Queen	ZZQMPZB	35.00
King	ZZKKMPZB	40.00

Shoulder Pillow

Case packs of 4

SIZE	SKU	PRICE
Queen	ZZQSCMPZB	35.00
King	ZZKSCMPZB	40.00



Shoulder

No MOQ, no charge to split case packs

wzc.maloufhome.com

800.517.7179

www.maloufhome.com

117

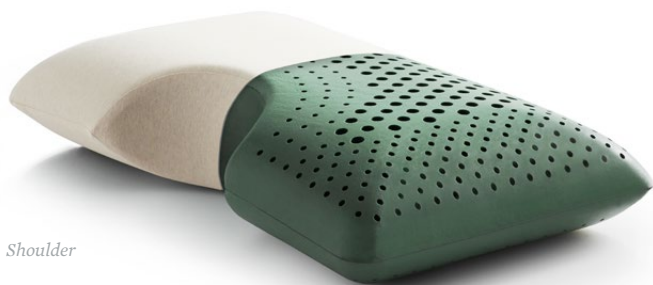

Shoulder

ZONED DOUGH™ + CBD OIL

- Pure CBD infusion can help soothe the senses and promote deeper and more restorative sleep; includes 4 mL spritzer of pure, organically grown CBD oil to be sprayed on the pillowcase for transdermal absorption
- Zoned Technology™ design cradles the head while supporting the neck
- Ventilated for increased airflow and breathability
- Dough™ formula creates a softer, more supportive memory foam
- 100% natural unbleached and undyed cotton cover
- 5-year limited warranty guarantees high-quality construction
- **Shoulder cutout** shape ideal for side sleepers

Pillow

Case packs of 4

SIZE	SKU	PRICE
Queen	ZZQQMPASZS	50.00
King	ZZKKMPASZS	55.00

Shoulder Pillow

Case packs of 4

SIZE	SKU	PRICE
Queen	ZZQQSCMPASZS	50.00
King	ZZKKSCMPASZS	55.00

CBD Spritzer



PRODUCT	SKU	PRICE
4 mL Spritzer (included)	ZZMBCDAS	8.00

No MOQ, no charge to split case packs

ZONED ACTIVEDOUGH™ + BAMBOO CHARCOAL



- Infused with bamboo charcoal to help regulate humidity, temperature, and odors
- ActiveDough™ foam combines the quick-response feel of latex and contouring relief of memory foam
- Zoned Technology™ design cradles the head while supporting the neck
- Ventilated for increased airflow and breathability
- Tencel™ Lyocell removable cover with superior moisture-management properties aids in optimal sleeping temperatures
- 5-year limited warranty guarantees high-quality construction

Pillow

Case packs of 4

SIZE	SKU	PRICE
Queen	ZZQKMPADZB	35.00
King	ZZKKMPADZB	40.00



No MOQ, no charge to split case packs

wzc.maloufhome.com | 800.517.7179 | www.maloufhome.com

121

ZONED ACTIVE DOUGH™ + CBD OIL



- Pure CBD infusion can help soothe the senses and promote deeper and more restorative sleep; includes 4 mL spritzer of pure, organically grown CBD oil to be sprayed on the pillowcase for transdermal absorption
- ActiveDough™ foam combines the quick-response feel of latex and contouring relief of memory foam
- Zoned Technology™ design cradles the head while supporting the neck
- Ventilated for increased airflow and breathability
- 100% natural unbleached and undyed cotton cover
- 5-year limited warranty guarantees high-quality construction

Pillow

Case packs of 4

SIZE	SKU	PRICE
Queen	ZZQQMPADASZS	50.00
King	ZZKKMPADASZS	55.00

CBD Spritzers



PRODUCT	SKU	PRICE
4 mL Spritzer (included)	ZZMMCBIDAS	8.00



No MOQ, no charge to split case packs | *Limited Stock

wzc.maloufhome.com | 800.517.7179 | www.maloufhome.com



Shoulder

AROMATHERAPY ZONED DOUGH™

- Dough™ formula, infused with aromatherapy oil, creates softer, more supportive memory foam
- Tencel™ Lyocell mesh removable cover with superior moisture-management properties aids in optimal sleeping temperatures
- Included 3 mL aromatherapy spray helps boost and maintain scent
- Zoned Technology™ design cradles the head while supporting the neck
- Ventilated for increased airflow and breathability
- 5-year limited warranty guarantees high-quality construction
- **Peppermint** is known to promote clarity of mind and healthy respiratory function
- **Lavender** is known to promote calming, relaxing, and rejuvenating sleep
- **Shoulder cutout** shape is ideal for side sleepers

Pillow

Case packs of 4

SIZE	SKU	PRICE
Queen	ZZQQMPASZ_	40.00
King	ZZKKMPASZ_	45.00

Shoulder Pillow

Case packs of 4

SIZE	SKU	PRICE
Queen	ZZQQSCMPASZ_	40.00
King	ZZKKSCMPASZ_	45.00

Aromatherapy Spray



SIZE	SKU	PRICE
3 mL Spritzer (included)	● ZZMPPMAS ● ZZMMLVAS	6.00

Infusions and SKU Codes

● P = Peppermint ● L = Lavender

No MOQ, no charge to split case packs | *Limited Stock

wzc.maloufhome.com | 800.517.7179 | www.maloufhome.com

125



AROMATHERAPY ZONED ACTIVEDOUGH™

- ActiveDough™ foam infused with aromatherapy oil; combines quick-response feel of latex and contouring relief of memory foam
- Tencel™ Lyocell mesh removable cover with superior moisture-management properties aids in optimal sleeping temperatures
- Included 3 mL aromatherapy spray helps boost and maintain scent
- Zoned Technology™ design cradles the head while supporting the neck
- Ventilated for increased airflow and breathability
- 5-year limited warranty guarantees high-quality construction
- **Peppermint** is known to promote clarity of mind and healthy respiratory function
- **Lavender** is known to promote calming, relaxing, and rejuvenating sleep



Pillow

Case packs of 4

SIZE	SKU	PRICE
Queen	ZZQQMPADASZ_	40.00
King	ZZKKMPADASZ_	45.00

Aromatherapy Spray



SIZE	SKU	PRICE
3 mL Spritzer (included)	● ZZMPPMAS	6.00
	● ZZMMLVAS	

Infusions And SKU Codes

● P = Peppermint ● L = Lavender

No MOQ, no charge to split case packs | *Limited Stock

wzc.maloufhome.com | 800.517.7179 | www.maloufhome.com

127



SHREDDED GEL DOUGH™

- Shredded clusters improve airflow and moldability
- Gel Dough™ formula creates a cooler, softer memory foam
- Gel Dough™ sleeve allows for a consistent, cool feel
- Tencel™ Lyocell removable cover with superior moisture-management properties aids in optimal sleeping temperatures
- 5-year limited warranty guarantees high-quality construction

Pillow

Case packs of 4

SIZE	SKU	PRICE
Queen	ZZQQGFSG	28.00
King	ZZKKGFSG	34.00



No MOQ, no charge to split case packs

wzc.maloufhome.com | 800.517.7179 | www.maloufhome.com

129



Shoulder

ZONED GEL DOUGH™

- Gel Dough™ formula creates a cooler, softer memory foam
- Zoned Technology™ design cradles the head while supporting the neck
- Ventilated for increased airflow and breathability
- 5-year limited warranty guarantees high-quality construction
- Tencel™ Lyocell removable cover with superior moisture-management properties aids in optimal sleeping temperatures
- **Shoulder cutout** shape ideal for side sleepers

High Loft Pillow

Case packs of 4

SIZE	SKU	PRICE
Queen	ZZQQHPZG	35.00
King	ZZKKHPZG	40.00

Mid Loft Pillow

Case packs of 4

SIZE	SKU	PRICE
Queen	ZZQQMPZG	35.00
King	ZZKKMPZG	40.00

Low Loft Pillow

Case packs of 4

SIZE	SKU	PRICE
Queen	ZZQQLPZG	35.00
King	ZZKKLPZG	40.00

Shoulder Pillow

Case packs of 4

SIZE	SKU	PRICE
Queen	ZZQQSCMPZG	35.00
King	ZZKKSCMPZG	40.00

No MOQ, no charge to split case packs



Shoulder

ZONED GEL ACTIVEDOUGH™

- Infused with cooling gel to regulate sleep temperature for optimal comfort
- ActiveDough™ foam combines the quick-response feel of latex and contouring relief of memory foam
- Ventilated for increased airflow and breathability
- Zoned Technology™ design cradles the head while supporting the neck
- Tencel™ Lyocell removable cover with superior moisture-management properties aids in optimal sleeping temperatures
- 5-year limited warranty guarantees high-quality construction
- **Shoulder cutout** shape ideal for side sleepers

Pillow

Case packs of 4

SIZE	SKU	PRICE
Queen	ZZQQMPADZG	35.00
King	ZZKKMPADZG	40.00

Shoulder Pillow

Case packs of 4

SIZE	SKU	PRICE
Queen	ZZQQSCMPADZG	35.00
King	ZZKKSCMPADZG	40.00

No MOQ, no charge to split case packs



Shoulder

GEL DOUGH™ + Z™ GEL

- Unique gel combination great for maximum cooling
- Z™ Gel layer captures and dissipates heat
- Gel Dough™ formula creates a cooler, softer memory foam
- Tencel™ Lyocell removable cover with superior moisture-management properties aids in optimal sleeping temperatures
- 5-year limited warranty guarantees high-quality construction
- **Shoulder cutout** shape ideal for side sleepers

High Loft Pillow

Case packs of 4

SIZE	SKU	PRICE
Queen	ZZQQHPGL	45.00
King	ZZKKHPGL	50.00

Mid Loft Pillow

Case packs of 4

SIZE	SKU	PRICE
Queen	ZZQQMPGL	45.00
King	ZZKKMPGL	50.00

Shoulder Pillow

Case packs of 4

SIZE	SKU	PRICE
Queen	ZZQQSCMPGL	45.00
King	ZZKKSCMPGL	50.00

No MOQ, no charge to split case packs

CARBONCOOL™ + OMNIPHASE™



- Infused with activated carbon and phase change material for constant temperature regulation that maintains the body's optimum sleep temperature
- Activated carbon infused in the foam creates pathways that move heat away from the head and neck
- Surface coated with OmniPhase™ phase change material, an advanced cooling technology that continuously absorbs and dissipates heat
- Soft, supportive memory foam relieves pressure points
- Ventilated for increased airflow and breathability
- Tencel™ Lyocell mesh removable cover with superior moisture-management properties aids in optimal sleeping temperatures
- 5-year limited warranty guarantees high-quality construction
- **Shoulder cutout** shape ideal for side sleepers; non-mesh Tencel™ Lyocell fabric cover



Shoulder

Pillow

Case packs of 4

SIZE	SKU	PRICE
Queen	ZZQQMPCCLT	50.00
King	ZZKKMPCCLT	55.00

Shoulder Pillow

Case packs of 4

SIZE	SKU	PRICE
Queen	ZZQQSCMPCCLT	50.00
King	ZZKKSCMPCCLT	55.00

No MOQ, no charge to split case packs

wzc.maloufhome.com | 800.517.7179 | www.maloufhome.com

ICE CLOUD™ + OMNIPHASE™



- 4x cooling technologies provide balance, increase airflow, and actively maintain the ideal sleep temperature
- Dual-sided feel with gel memory foam on one side of the pillow and shredded foam and down-alternative fill on the other side
- CoolSync™ memory foam side features a cooling gel infusion and breathable ventilation channels
- A layer of OmniPhase™ phase change material on one side actively absorbs and dissipates heat for continual temperature regulation
- Back side of pillow has shredded CoolSync™ memory foam and down alternative fill for a more traditional feel
- Innovative HyperChill™ cover offers an instant cooling effect for refreshing sleep
- Available in low, mid, and high-loft options to accommodate all sleep styles
- 5-year limited warranty guarantees high-quality construction
- Available end of Q3

High Loft Pillow

Case packs of 4

SIZE	SKU	PRICE
Queen	ZZKKHPICGF	60.00
King	ZZKKHPICGF	65.00

Mid Loft Pillow

Case packs of 4

SIZE	SKU	PRICE
Queen	ZZQMPICGF	60.00
King	ZZKMPICGF	65.00

Low Loft Pillow

Case packs of 4

SIZE	SKU	PRICE
Queen	ZZQLPICGF	60.00
King	ZZKLPICGF	65.00

No MOQ, no charge to split case packs



ZONED TALALAY LATEX

- 100% natural Talalay latex with no synthetic additives
- Zoned Technology™ design cradles the head while supporting the neck
- Ventilated for increased airflow and breathability
- 100% natural cotton removable cover offers a crisp, clean, and breathable pillow surface
- 5-year limited warranty guarantees high-quality construction

High Loft Pillow

Case packs of 4

SIZE	SKU	PRICE
Queen Plush	ZZQQHPLX	45.00
Queen Firm	ZZQQHFLX	45.00
King Plush	ZZKKHPLX	50.00
King Firm	ZZKKHFLX	50.00

Low Loft Pillow

Case packs of 4

SIZE	SKU	PRICE
Queen Plush	ZZQLPLX	45.00
Queen Firm	ZZQLFLX	45.00
King Plush	ZZKLPLX	50.00
King Firm	ZZKLFLX	50.00



No MOQ, no charge to split case packs

wzc.maloufhome.com | 800.517.7179 | www.maloufhome.com

LOUNGE™



- Shredded memory foam blend fill
- Supports arms and upper body to reduce back and shoulder strain
- Enhanced comfort while reading, browsing, or watching TV in bed
- Super soft and cozy rayon from bamboo cover showcases an elegant jacquard design
- 3-year limited warranty guarantees high-quality construction
- Pillow measures 35 x 22 x 17 inches

Pillow

Case packs of 4

SIZE	SKU	PRICE
Reading Pillow	ZZ00SFRP	29.00



No MOQ, no charge to split case packs

wzc.maloufhome.com

800.517.7179

www.maloufhome.com

WEDGE

- Angled design helps relieve snoring, heartburn, acid reflux, and sinus pressure
- Supportive base foam maintains shape
- Standard size pillow width; pillow measures 24 x 24 x 7 inches
- Super soft and cozy rayon-from-bamboo cover showcases an elegant jacquard design
- Firm, supportive foam maintains shape
- 3-year limited warranty guarantees high-quality construction



Case packs of 4

SIZE	SKU	PRICE
Wedge Pillow	ZZ2407FW	26.00

No MOQ, no charge to split case packs

www.maloufhome.com

800.517.7179

www.maloufhome.com

145

BODY PILLOWS



- Provides back and belly support to alleviate maternity discomfort
- Versatile design provides customized support
- Luxurious down-alternative fill feels like down without odors, allergens, or sharp quills
- Tencel™ Lyocell removable cover with superior moisture-management properties aids in optimal sleeping temperatures
- 3-year limited warranty guarantees high-quality construction



Horseshoe



Wrap-Around

Horseshoe

- Measures 28 x 30 x 7 inches

Case packs of 4

SIZE	SKU	PRICE
Horseshoe Pillow	ZZPUHFGM	32.00

Wrap-Around

- Elevates and aligns the hips for a neutral sleeping position
- Measures 52 x 28 x 7 inches

Case packs of 4

SIZE	SKU	PRICE
Wrap-Around Pillow	ZZPJHFGM	41.00

No MOQ, no charge to split case packs



L-SHAPE

- Ergonomic shape provides support for the head, neck, and shoulders
- Offers comfort for multiple sleep positions
- Gel Dough™ formula creates a cooler, softer memory foam
- Tencel™ Lyocell removable cover with superior moisture-management properties aids in optimal sleeping temperatures
- 5-year limited warranty guarantees high-quality construction
- Pillow measures 27 x 27 x 5 inches

Pillow

Case packs of 4

SIZE	SKU	PRICE
L-Shape Pillow	ZZ00LLGF	36.00



No MOQ, no charge to split case packs

TRAVEL PILLOWS

Travel Pillow

- All the benefits of your favorite Malouf™ pillow in a convenient travel size
- Available in a variety of materials and covers
- Smaller size great for easy packing

SIZE	SKU	PRICE
A. Shredded <i>Gel Dough</i> ™	ZZTRGFSG	12.00
B. <i>Zoned Dough</i> ™ + Lavender	ZZTRMPASZL	16.00
C. <i>Gel Dough</i> ™ + <i>Z</i> ™ Gel	ZZTRHPGL	16.00
D. <i>CarbonCool</i> ™ + <i>OmniPhase</i> ™	ZZTRMPCCLT	25.00



A



B



C



D



E

Travel Neck Pillow

- All the benefits of your favorite Malouf™ pillow in a convenient travel size
- Wraps around the neck for total support

SIZE	SKU	PRICE
E. <i>Zoned Dough</i> ™ + Lavender	ZZTNMPASZL	12.00

No MOQ, no charge to split case packs

wzc.maloufhome.com | 800.517.7179 | www.maloufhome.com

Our bed frames are durable, packaged attractively, and priced to sell.

BED FRAMES



ADJUSTABLE BED FRAME

**UNIVERSAL BED FRAME
WITH ROLLERS**
ADJUSTABLE TO FIT TWIN, TWIN XL, FULL, FULL XL, QUEEN, KING, CAL KING

MALOUF

UNIVERSAL BED FRAME WITH ROLLERS - 100% SOLID STEEL CONSTRUCTION - 3 YEAR WARRANTY
 AVAILABLE IN 10 COLORS - 100% SOLID STEEL CONSTRUCTION - 3 YEAR WARRANTY

- Patented Tri-Support™ system reinforces steel joints for optimal support
- Longer rails accommodate extra-long beds and offer increased stability; up to 9 support legs
- Extra-wide double rail center support
- Universal size fits Twin, Twin XL, Full, Full XL, Queen, King, and California King
- Pre-installed headboard brackets are compatible with most headboards
- Choose the 2.5-inch in-line rug roller option with locking wheels, great for carpeted floors; or choose the glide option designed for hard floors
- 100% solid steel construction
- 3 to 5-year limited warranty guarantees high-quality construction (3-year warranty on MA4633)

Glide Only Frame

Optimal shipping economies = by the pallet

SIZE	SKU	PRICE
Full/Twin	MA4633GL	30.00
Queen/Full/Twin	MA5033GL	40.00
¹ Universal	MA6633GL	50.00

Rug Roller Frame

Optimal shipping economies = by the pallet

SIZE	SKU	PRICE
Full/Twin	MA4633BF	30.00
Queen/Full/Twin	MA5033BF	40.00
¹ Universal	MA6633BF	50.00

¹Shown to the left

NOTE: Bed rail systems are available in the Weekender™ product line

No MOQ

wrc.maloufhome.com | 800.517.7179 | www.maloufhome.com

155

HIGHRISE™ LT



- Eliminates the need for a box spring
- Provides 14 or 18 inches of underbed storage space
- Now with easier assembly—new tightening system requires no additional tools or hardware
- Folded and boxed for easy storage and transport
- 2,000-pound weight capacity
- 5-year limited warranty guarantees high-quality construction

14" Bed Frame

Optimal shipping economies = by the pallet

SIZE	SKU	PRICE
Twin	ST22TTFP	60.00
Twin XL	ST22TXFP	65.00
Full	ST22FFFP	80.00
Queen	ST22QQFP	85.00
King	ST22KKFP	95.00
California King	ST22CKFP	105.00

18" Bed Frame

Optimal shipping economies = by the pallet

SIZE	SKU	PRICE
Twin	ST22TT18FP	75.00
Twin XL	ST22TX18FP	80.00
Full	ST22FF18FP	90.00
Queen	ST22QQ18FP	100.00
King	ST22KK18FP	115.00
California King	ST22CK18FP	115.00

Headboard Brackets

Optimal shipping economies = by the pallet

SIZE	SKU	PRICE
Headboard Brackets for Highrise Frames	ST14HBHR2	15.00

No MOQ

TOPPERS



*Customers continue to ask for toppers—
provide the very best with Malouf®. Soften a
too-firm mattress, add a cooling layer, or guide
customers toward a new mattress purchase.*



3" DOWN ALTERNATIVE

- Down-alternative filling adds a soft layer to any mattress without odors, allergens, or sharp quills associated with down and feathers
- 250-thread-count pure cotton percale cover offers a crisp, clean, and breathable surface
- Baffle-box construction keeps fill from clumping or shifting
- Thick elastic anchor bands secure topper at mattress corners
- 3-year limited warranty guarantees high-quality construction

Mattress Topper

SIZE	SKU	PRICE
Twin	IS30TTDAFB	45.00
Twin XL	IS30TXDAFB	50.00
Full	IS30FFDAFB	55.00
Queen	IS30QQDAFB	65.00
King	IS30KKDAFB	80.00
California King	IS30CKDAFB	85.00



No MOQ, no charge to split case packs

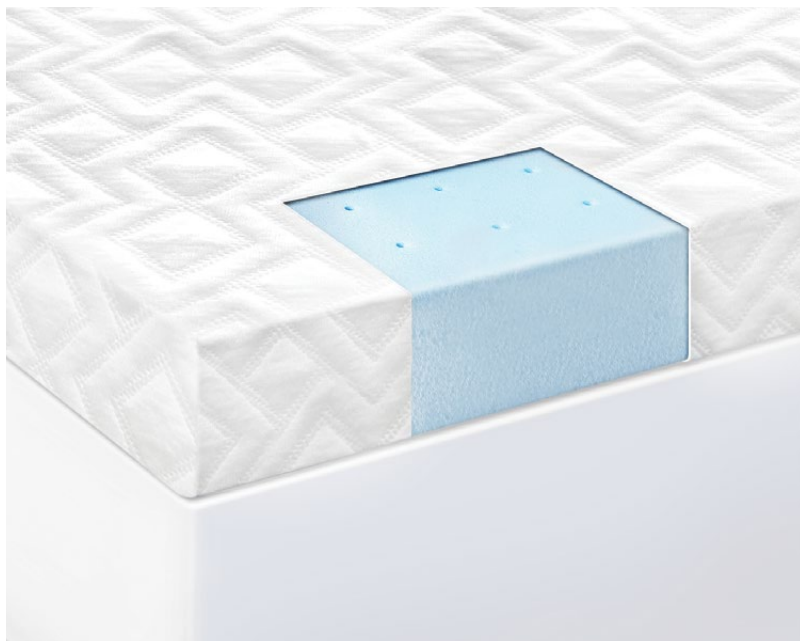

2.5" GEL MEMORY FOAM

- 2.5-inch thick gel-infused memory foam offers superior cooling
- Removable rayon from bamboo cover
- Ventilated to increase airflow and regulate sleeping temperature
- 3-year limited warranty guarantees high-quality construction
- Soft, supportive consistency quickly conforms to the body

Mattress Topper

SIZE	SKU	PRICE
Twin	IS25TT45GT	60.00
Twin XL	IS25TX45GT	65.00
Full	IS25FF45GT	80.00
Queen	IS25QQ45GT	90.00
King	IS25KK45GT	115.00
California King	IS25CK45GT	125.00



No MOQ, no charge to split case packs

wrc.maloufhome.com | 800.517.7179 | www.maloufhome.com

163



POINT OF PURCHASE (POP) GUIDELINES

We have everything you need to support your sales. Showcase Malouf™ products with our uniquely designed racks, cases, and accessories.

POP Allowance Program

Once per calendar year, each store unit will receive a one-time, \$100 POP allowance after a cumulative annual purchase of \$1,000 or more.

POP items are included with your product orders to save on freight costs when possible.

Questions?

For best POP practices and tips, as well as additional details on items listed here, please contact your sales rep or a Malouf™ sales associate at sales@maloufhome.com.



MATTRESS DISPLAYS

Foot and Pillow Protectors

- Foot protector guards your display mattress against dirt and stains
 - Charcoal fabric is designed for durability
 - Non-slip backing for a smooth fit
 - Easily display pricing with two insert pockets (download free inserts on the WRC)
- Matching pillow protector provides a comfortable and clean mattress testing experience for your customers
 - Charcoal fabric is designed for durability
 - Fits a Queen-size pillow (not included)

PRODUCT	SKU	PRICE
Foot Protector - Twin	MM01TTFP	30.00
Foot Protector - Queen	MM01QQFP	35.00
Foot Protector - King	MM01KKFP	40.00
Pillow Protector	MA00QQPC	20.00

MATTRESS DISPLAYS

Foam Touch Stations

- Display allows customers to compare and interact with different materials



PRODUCT	SKU	PRICE
A- Ice Cloud™ CoolSync™	MM00ICCSFOAM (foam block)	5.00
	MAMMICCSBOX (box)	30.00
B- Ice Cloud™ ActivAir™	MM00ICAAFOAM (foam block)	5.00
	MAMMICAABOX (box)	30.00
C- Ice Cloud™ AeroFlex™	MM00ICAFFOAM (foam block)	5.00
	MAMMICAFFBOX (box)	30.00
D- CoolSync™ (Neve/Polaris™)	MM00CSFOAM (foam block)	5.00
	MAMMCSBOX (box)	30.00
E- ActivAir™ (Neve/Polaris™)	MM00AAFOAM (foam block)	5.00
	MAMMAABOX (box)	30.00
F- AeroFlex™ (Neve/Polaris™)	MM00AFFOAM (foam block)	5.00
	MAMMAFFBOX (box)	30.00





Polaris™



Ice Cloud™



Neve

¹QUALIFYING SALES AMOUNT

Mattress displays are free when you purchase qualifying amounts of correlating product within a 12-month period. Accounts will be credited the full price of the display upon meeting the qualifying sales amount.

MATTRESS DISPLAYS

Headboard Backdrops

- Fabric headboard with aluminum frame educates customers on the features and benefits of each mattress line: Neve, Polaris™, and Ice Cloud™

Headboard Fabric Inserts

PRODUCT	SKU	PRICE
Neve Fabric	MAMMNEHB	100.00
Polaris™ Fabric	MAMMPOHB	100.00
Ice Cloud™ Fabric	MAMMICHB	100.00
Blank Black Backer Fabric	MAMMHBBACK	75.00

Aluminum Frame

PRODUCT	SKU	QSA¹	PRICE
Aluminum Frame	MAMMHBFRAME	7,500	400.00

What Fabric Inserts Should I Order with a Frame?

TO DISPLAY AGAINST A WALL:

Order your mattress fabric of choice. Because the wall will hide the reverse side, a black backer fabric is not necessary.

TO DISPLAY FREESTANDING (SINGLE-SIDED):

For a clean finish, order your mattress fabric of choice and a black backer fabric.

TO DISPLAY BACK-TO-BACK:

To show two mattresses back-to-back, order two mattress fabrics, one for each side of the display. Black backer fabric is not necessary.

BUNDLE BOXES



- Display bedding bundles in a clear and organized way
- Cross-sell sleep accessories and increase average order value
- Consolidate decision-making for your customers
- Features educational content on the importance of the right pillows, protectors, and sheets
- Includes one insert per box; choose from Cooling, Natural, Value, or Deluxe

ITEM	SKU	PRICE
Cooling Bundle Box	MA2614DTC	75.00
Natural Bundle Box	MA2614DTN	75.00
Value Bundle Box	MA2614DTV	75.00
Deluxe Bundle Box	MA2614DTD	75.00



CUSTOM SLEEP ACCESSORY DISPLAY

- Creatively display your choice of Malouf™ pillows, sheets, or protectors; or present a combination of all three product categories
- Customized your layout with display boxes and shelves for maximum customer engagement
- Choose from a 13-inch white display or 17-inch black display
- Black box includes slots on either side for easy display of rigid signage
- Alternate between five recommended configurations for quick and easy customization
- Angled shelves can showcase any assortment of Malouf™ pillows; choose from a 3- or 4-pack based on your merchandising needs
- Vertical structure allows you to display a wide range of sleep accessories without crowding your floor space
- Black brushed steel creates a refined look and adds a touch of sophistication to any showroom

Modular Display Rack

CONFIGURATION	SKU	QSA ¹	PRICE
A- (4) Shelves + (2) 13" White Boxes	MAMODRACKA	4,000.00	250.00
B- (6) Shelves + 13" White Box	MAMODRACKB	4,000.00	250.00
C- (3) 13" White Boxes + 17" Black Box	MAMODRACKC	4,000.00	250.00
D- (9) Shelves	MAMODRACKD	4,000.00	250.00
E- (4) Shelves + 13" White Box + 17" Black Box	MAMODRACKE	4,000.00	250.00
F- (3) Shelves + Rack Bar + 13" White Box	MAMODRACKF	4,000.00	230.00

ITEM	SKU	PRICE
Outer Frame	MA3690BKDR	100.00
13" White Display Box	MA13BXWHDR	50.00
17" Black Display Box	MA17BxBKDR	60.00
Shelves - 3 pack	MA3SWHDR	60.00
Shelves - 4 pack	MA4SWHDR	75.00
Rack Hanging Bar + 10 Rings and Clips	MA33BKBARDR	30.00

¹QUALIFYING SALES AMOUNT

Display racks are free when you purchase qualifying amounts of correlating product within a 12-month period. Accounts will be credited the full price of the display rack upon meeting the qualifying sales amount.



36" x 15" x 90"



33.5" x 15" x 17"



33.5" x 15" x 13"



33.5" x 15"

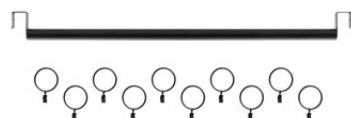

MULTIPLE CONFIGURATIONS

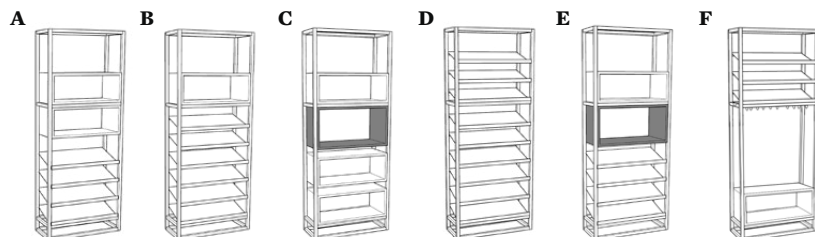

Shown above

METAL HEADBOARD DISPLAY

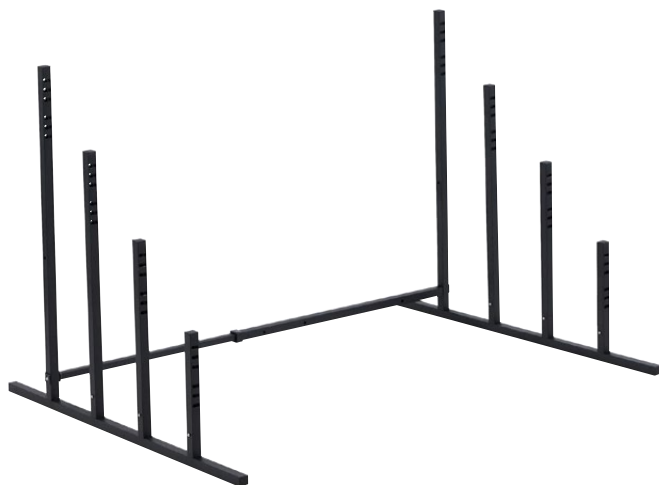

- Easily display up to four headboards
- Durable black powder-coated finish
- Non-branded tiered rack
- Complete hardware pack included
- Uses space efficiently to showcase several pieces in one place
- Rack measures 44" (L) x 59.4" (W) x 37.6" (H) when fully extended
- Adjustable width fits Twin to King sizes
- Compatible with all Malouf and Weekender headboards

PRODUCT	SKU	QSA ¹	PRICE
Headboard Display	ST4THBDPRK	500.00	75.00



Product not included

¹QUALIFYING SALES AMOUNT

Display racks are free when purchasing qualifying amounts of correlating product within a 12-month period. Accounts will be credited the display rack price upon meeting the qualifying sales amount.



Product not included

WALL MOUNT DISPLAY

- Easily display a lineup of pillows through a sleek and efficient vertical rail system
- Specially designed to accommodate Malouf™ pillows for a perfect fit
- Screw directly into the wall for a secure display
- Hook attachments allow for adjustable shelf height
- Top with a Malouf™ sign to complete the display (order separately)
- Includes necessary bolts, nuts, washers, and wrenches
- Front lip holds pillows in place
- Display rack measures 78.7 x 24 x 1.5 inches

Rack

Includes your choice of 4 shelves (1 set)

PRODUCT	SKU	QSA ¹	PRICE
Rack with 4 Shelves	ZZ78VT04FLWHDR	2,000.00	125.00

Malouf™ Sign

PRODUCT	SKU
Malouf™ Sign	ZZ78VTDRSIGN

¹QUALIFYING SALES AMOUNT

Display racks are free when purchasing qualifying amounts of correlating product within a 12-month period. Accounts will be credited the display rack price upon meeting the qualifying sales amount.

*Limited Stock

MALOUF

SLEEP PRODUCTS



OUTFIT YOUR DISPLAYS

to Enhance Your Customer's Experience

PRODUCT	SKU	PRICE
Adjustable Base Retainer Bar Cover	MA01STRBC	20.00
Furniture Color Swatch Book	MA00MMFNSB	10.00

PRODUCT	SKU	PRICE
LED Malouf™ Window Sign	MA36SPLED	400.00

Protectors

PRODUCT	SKU	PRICE
Pr1me™ Terry Protector (Mini)	SL00MMMP	3.00
Pr1me™ Smooth Protector (Mini)	SL0PMMMP	3.00
Five Sided™ Protector (Mini)	SL0PMM5P	3.00
Five Sided™ OmniPhase™ Protector (Mini)	SL0TMM5P	7.00
Five Sided™ IceTech™ Protector (Mini)	SLICMM5P	7.00
Encase™ HD Protector (Mini)	SL0PMMEP	7.00
Mattress (Mini)	SL00MMM	10.00
Plush Dust Mite (6 x 12 Inches)	SL00MMDM	5.00
Terry Swatch Pack (10 Pieces)	SL00MMSW	2.00
Smooth Swatch Pack (10 Pieces)	SL0PMMSW	2.00
OmniPhase™ Swatch Pack (10 Pieces)	SL0TMMSW	3.00
Sleep Tite™ Jar	SL00MMJR	10.00

Bedding, Pillows, and Toppers

PRODUCT	SKU	PRICE
Brushed Microfiber Swatch Set	MA90MMSSB	15.00
Rayon from Bamboo Swatch Set	MA25MMBSSB	15.00
Tencel™ Lyocell Swatch Set	MA03MNTSSB	15.00
Supima® Cotton Swatch Set	MAS6MMSSSB	15.00
BIAB Comforter White (Mini)	MA01MMWHWHBB	15.00
Acrylic Display Case	MA00MM03DC	250.00
Bamboo Charcoal Dough™ Football	ZZMMFBDF	7.00
Gel Dough™ Football	ZZMMFBGF	7.00
Lavender Dough™ Football	ZZMMFBLF	7.00
Disposable Pillow Slips (50 Count)	<td>3.00</td>	3.00
2.5" Gel Memory Foam Mini Topper	IS25MM45GT	10.00

*Limited Stock

ORDER TODAY

1.800.517.7179
wrc.maloufhome.com

VISIT OUR SHOWROOMS

NEW YORK
230 Fifth Avenue, Suite 1312

LAS VEGAS
World Market Center, Suite B1350

HIGH POINT
Market on Green, Suite 100-101